

Siting Plan and Concept Designs for Living Shoreline Projects on the Inland Bays

Final Project Report

Grant Agreement # SWMPG 16-01

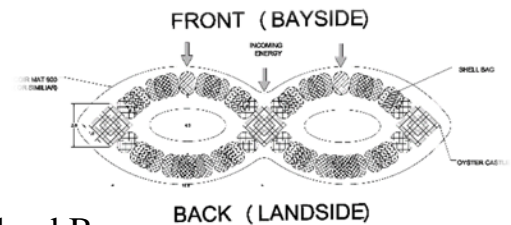
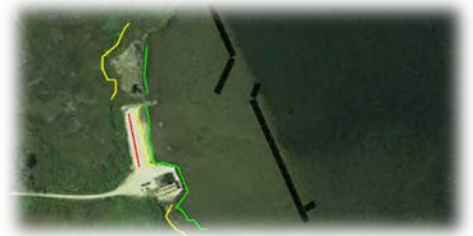
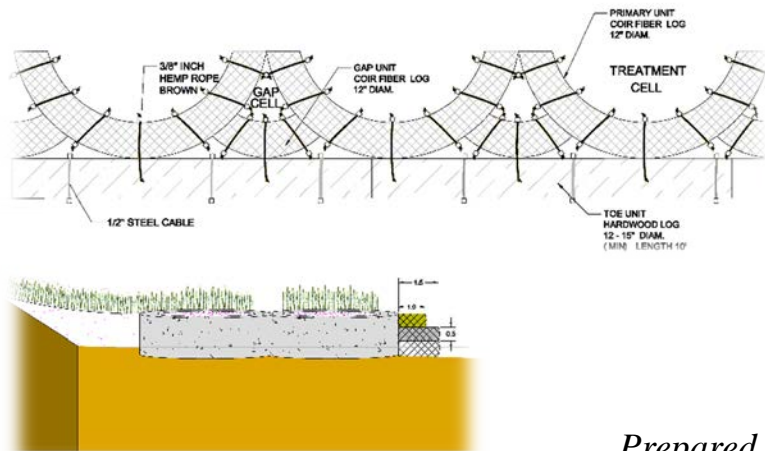

Prepared for:
Delaware Center for the Inland Bays
39375 Inlet Road
Rehoboth Beach, DE 19971
&
Sussex Conservation District
23818 Shortly Road
Georgetown, DE 19947

Prepared by:
Sovereign Consulting Inc.
50 West Welsh Pool Road
Suite 6
Exton, PA 19341

December, 2016



This project was funded by Surface Water Matching Planning Grant No. 16-01 from the Delaware Water Infrastructure Advisory Council. Partial funding also was provided by the DNREC Division of Watershed Stewardship, and by the United States Environmental Protection Agency under assistance agreements CE09939912 and CE09939913 to the Delaware Center for the Inland Bays. The contents of this document do not necessarily reflect the views and policies of the Environmental Protection Agency, nor does the EPA endorse trade names or recommend the use of commercial products mentioned in this document.

TABLE OF CONTENTS **PAGE NO.**

Introduction.....	1
Part 1 -Screening Effort.....	2
Part 2 - Concept Designs.....	8
Part 3 - Dredge Re-Use Discussions.....	17
Summary and Discussion.....	20

FIGURES:

Figure 1. The Delaware Inland Bays Watershed.....	1
Figure 2. Standard Deviation Plot and Curve of the Tier 2 Screening Scores.....	7
Figure 3. Dredge Re-Use Living Shoreline Demonstration Sites.....	18

TABLES:

Table 1. Scoring Matrices Framework.....	6
Table 2. Cost Estimate VFW at Quillens Point	9
Table 3. Cost Estimate Swann Keys.....	10
Table 4. Cost Estimate Angola by the Bay.....	12
Table 5. Cost Estimate Shell Landing Cove	13
Table 6. Cost Estimate Dewey Beach at Sunset Park	14
Table 7. Cost Estimate Inlet Road East.....	15
Table 8. Demonstration Living Shoreline Site Summaries.....	16
Table 9. Listing of Identified Dredge Re-Use Demonstration Living Shoreline Sites.....	19

EXHIBITS:

Exhibit 1 – Exclusions.....	3
Exhibit 2 - Areas of Special Interest Inclusions.....	3
Exhibit 3 - Criteria Listing.....	4
Exhibit 4 - Example Criteria Scoring Matrix.....	6
Exhibit 5 - CIB’s Top 10 Priority Sites.....	8

INTRODUCTION

Delaware's three Inland Bays (Bays) are a major economic and natural resource for Sussex County and the State of Delaware. The shorelines of these coastal bays are dynamic transition zones between open waters and their adjacent beaches, marshes and uplands. Natural shorelines provide high-value ecosystem services to the residents of Delaware, including maintenance of estuarine water quality, prevention of erosion, removal and storage of excess nutrients, and provision of critical habitat for finfish, shellfish, and coastal bird species. The majority of the Bays' shorelines are experiencing erosion at some level. Sea level rise (SLR) continues to have an increasing effect on our shoreline erosion and marsh health.

Extensive nearshore development is a major factor in the widespread alteration of the shorelines of the Bays. Traditionally, attempts to control shoreline erosion have included building bulkheads or placing rocks directly on the shorelines. These "hard-armoring" shoreline stabilization tactics reduce or eliminate many water quality and other environmental benefits provided by shorelines and adjacent marshes. Nearshore estuarine environments are also scoured and degraded by hard-armoring, and adjacent natural shorelines often experience increased erosion due to reflected, refracted, and diffracted wave energy.

The use of "Living Shorelines" offers a nature-based alternative for shoreline stabilization and increased resilience, focusing on the use of naturally occurring materials to maintain or enhance environmental benefits of bay shorelines, including the trapping of nutrients and sediments. A variety of natural structures can be used in living shorelines, such as shellfish reefs, submerged grass beds, logs, and native wetland vegetation. Living shorelines are a class of green infrastructure projects that is growing in importance as SLR increases and as severe weather becomes more frequent and extreme. Living shorelines mimic natural processes that attenuate wave energy rather than fight wave energy. Because of their ability to prevent sediment loss and to trap nutrients, promotion of their use is increasing throughout the country. A Chesapeake Bay Program expert panel, for example, concluded that the pollutant load reduction credit for living shoreline practices can be much higher than for many other urban BMPs.

Multiple agencies and organizations in the state – including DNREC, the Delaware Center for the Inland Bays (CIB), the Partnership for the Delaware Estuary (PDE), The Nature Conservancy, and others – have undertaken initiatives to maximize the use of living shoreline stabilization techniques in order to protect the water quality and habitat of Delaware's estuaries. In the Bays watershed, this effort is led by the CIB. A Living Shoreline Initiative is an important component of the Comprehensive Conservation and Management Plan (CCMP) for the Inland Bays. An important part of the Inland Bays Living Shoreline Initiative is the creation of publically accessible, local demonstration projects that can be used as tools for educating the public and marine contractors about living shoreline techniques and benefits.

This report describes the results of a project to select up to six sites for living shoreline demonstration projects in the Bays, and to develop permit-level concept designs for them. Implementation of the

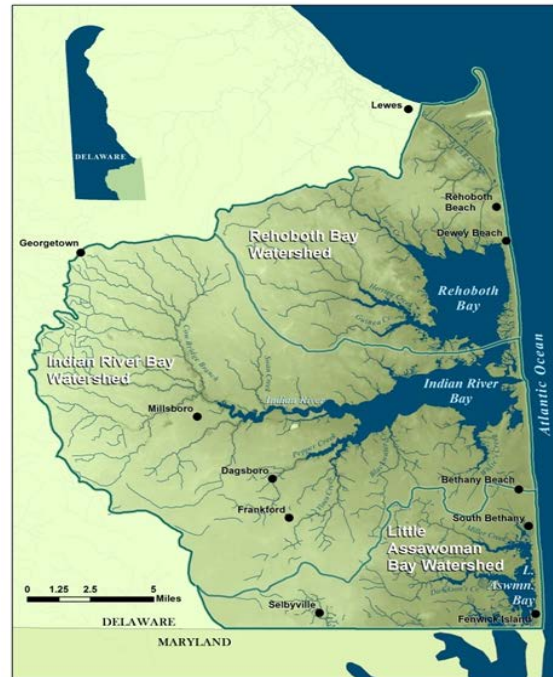

Figure 1. The Delaware Inland Bays Watershed.

projects selected through this planning effort is intended to result in increased adoption of the practice by private landowners and municipalities, leading to statewide water quality benefits for the public.

An additional goal of the project was to integrate into the site selection process a preliminary review of appropriate areas for beneficial reuse of dredged materials in living shorelines, and to produce a preliminary map of potential project areas for reuse within the Bays watershed.

The primary purpose of the project was to identify, screen, score, prioritize, and advance demonstration living shoreline projects within the three Bays systems. Essentially, the entire shoreline of all three Bays was required to be evaluated. The objective of the Tier 1 Screening was to develop and perform a desktop, watershed scale, screening process, using Geographic Information Systems (GIS) analyses, to identify a manageable number of shoreline reaches within the Bays systems for further evaluation under the Tier 2 Screening. This approach generated a dynamic geospatial database designed to allow the rapid screening of potential sites through simple query of site attributes.

PART 1 – SCREENING EFFORT

Tier 1 Screening

Current aerial imagery of tidal shorelines and tributaries of the three Bays and the Salt Pond (SP) were screened. The Tier 1 Screening process focused on three criteria: 1) Site Access – demonstration sites need to be accessible to the public; 2) Areas of Special Interests – areas having private/public support, existing avenues of funding, and/or areas having special outreach or ecological significance to CIB, DNREC, or the Sr. Restoration Ecologist at Sovereign Consulting, Inc. (Sovereign); and 3) proximity to known State dredging projects for re-use opportunities. All retained potential living shoreline sites were incorporated into a project-specific ArcGIS shapefile/database with individual points representing each potential living shoreline site.

Specific criteria were developed to assess access and dredge re-use potential. Special interest sites, which were not identified in the initial aerial imagery review (i.e., sites with access and dredge reuse potential), were added to the database. All retained potential living shoreline sites were incorporated into a project-specific ArcGIS shapefile/database with individual points representing each potential living shoreline site. To achieve the Tier 1 Screening objective, inclusive and exclusive screening criteria were developed, and is provided in Exhibits 1 and 2. After all potential and special interest sites were added to the database, site-specific attributes were added for future screening purposes.

Attributes incorporated into the database included the following:

- Site Name
- Ownership (Private, Federal, State, Local, Commercial, Industrial)
- Ownership qualification (HOA, Individual, Multiple)
- Within 4,000 feet of historically State-maintained/dredged channel (Yes, No)
- Shoreline Type – (Rip-Rap, Beach, Marsh, Maintained/Green, Mixed, Structured)
- Special Interest – (CIB, DNREC, Sovereign)
- Access type – (Direct, Indirect)
- Bay – Rehoboth (R), Indian River (IR), Little Assawoman (LA), and Salt Pond (SP)
- Owner Name
- State Parcel ID
- Mailing Address
- City/State - obtain from Sussex County Parcel data
- X and Y coordinate (DE State Plane Feet)

EXHIBIT 1

EXCLUSIONS:

- Any shoreline with a fetch of less than 300 ft. ENERGY & STUDY AREA LIMIT DRIVEN;
- Any water above the tide line and/or above full obstructions (e.g., dams) ENERGY DRIVEN
- Any shoreline more than 500 feet from a maintained roadway, dock, major publically maintained trail, golf course path, and certain established farms roads (farm roads discretionary per aerial interpretation) ACCESS & SAFETY DRIVEN
 - The 500-foot distance applies to common shorelines, i.e., the 500-foot distance does not jump across channels, and the average distance where one would need to cross an undisturbed marsh would be less than 150 feet.
 - Islands or former island footprints within the 500-foot limit that were present within the past 25 years and/or within 500 feet of the centerline of a State maintained channel are included;
 - When continuous beach edges are present, the 500-foot limit may be extended to a total of 750 feet;
 - When a waterway creates a barrier for foot traffic within the 500-foot limit, the waterway becomes the limit regardless of the distance;
 - Major Highways (e.g., SR 1) are excluded (local routes (e.g., Routes 54, 26, 24, etc.) are not considered major highways);
- Bulkheaded shorelines (most rip-rap shorelines are to be included, heavily rip-rapped shorelines may be considered to be functionally similar to bulk heads) ENERGY & COST DRIVEN
- Military Facilities ACCESS DRIVEN
- Private or secluded residences with up to 3 homes ACCESS DRIVEN.
- Canals SPACE, ACCESS & SAFETY DRIVEN

EXHIBIT 2

AREAS OF SPECIAL INTEREST INCLUSIONS:

- Shorelines within 4,000 feet of a historically State-maintained channel (excluding Cozy Cove, Feeder Beach at IRI, Rehoboth Bay Barrow Pits, and Wilson Creek) provided they do not meet any of the ACCESS & SAFETY DRIVEN exclusions;
- Communities adjacent to shorelines, with a HOA, and have been identified by CIB, or DNREC, to be (or likely to be in the near future) an active Partner in a shoreline restoration initiative SPECIAL INTEREST;
- Marinas that have been identified by CIB, or DNREC, to be (or likely to be in the near future) as an active Partner in a shoreline restoration initiative SPECIAL INTEREST; and
- Publically owned shorelines of special interest (e.g., Towers Road, Savage Ditch Road, Holts Landing) identified by CIB or the State SPECIAL INTEREST.
- Active private landowners or holdings, working with the CIB or State, that have/will enter into an access agreement to allow public viewing of site at some acceptable level and/or times SPECIAL INTEREST.
- For municipal or other developed communities, the following applies:
 - a. Relatively undeveloped privately-owned properties with more than 200 feet of shoreline are included (provided they are not excluded by other exclusion criteria);
 - b. Open space areas with more than 200 feet of shoreline are included (provided they are not excluded by other exclusion criteria);
 - c. Developed properties or lots, with disturbed shorelines (bulk headed, heavily rip-rapped, or similar), having less than 200 feet of shoreline are excluded unless identified as a special interest area.

The Tier 1 Screening effort identified 84 site within the Bays system; 38 in Rehoboth Bay, 28 in the Indian River Bay (including 2 in the Salt Pond), and 18 in the Little Assawoman Bay (see Appendix A, Figures A1, A2, and A3). Figure A4 depicts the 29 of the 84 site that are special interest sites. Figure A5 depicts the 44 of the 84 sites that are within 4,000 feet of a State dredging project.

Tier 2 Screening

The Tier 2 Screening involved two distinct efforts: (1) selection of the Tier 2 Screening criteria, and (2) development of scoring matrices for the selected criteria and the scoring of the 84 sites. Due to the large number of potential stakeholders who could be involved in a living shoreline project, every effort was made to select a set of Tier 2 Screening criteria that provided a holistic evaluation. During a meeting at the CIB office and subsequent discussions, a total of 61 potential criteria were identified consisting of 12 category criteria and 49 sub category criteria (see Exhibit 3).

In order to narrow the scoring criteria to a manageable number, only the criteria having the most universal interest between stakeholders were selected. This was accomplished by developing a non-parametric Mixed-Paired Comparison (MPC) test worksheet (Worksheet) to evaluate the 61 criteria (a sample

EXHIBIT 3 CRITERIA LISTING		
<p>Aesthetics</p> <ul style="list-style-type: none"> • Green (natural look) • Blending (integration) • Short-term • Long-term <p>Ownership</p> <ul style="list-style-type: none"> • Private (individual) • Private (HOA managed) • Federal • State • Local/municipal • Commercial • Industrial <p>Energy System</p> <ul style="list-style-type: none"> • Low • Moderate • High <p>Living Shoreline Type</p> <ul style="list-style-type: none"> • Conventional • Armored Hybrid • Energy Dissipating Hybrid 	<p>Feasibility</p> <ul style="list-style-type: none"> • Permitability • Project Cost • Established Technology • Technical Innovation • Adjacent Property Benefits/Burdens • Operation & Maintenance <p>Outreach</p> <ul style="list-style-type: none"> • Contractors & Other Professionals • General Public • Decision Makers <p>Climate Change</p> <ul style="list-style-type: none"> • SLR • Acute Severe Weather • Flood Mitigation • Resilience <p>Socioeconomics</p> <ul style="list-style-type: none"> • Ecosystem Services • Commercial Interests • Protection of Investment 	<p>Ecological Functions (resource uplift)</p> <ul style="list-style-type: none"> • Marsh • Shellfish • Nekton • Habitat Structure • SAV • Shorelines • Horseshoe Crab • Shorebirds <p>Water Quality</p> <ul style="list-style-type: none"> • Nutrient Reductions/Processing • Carbon Sequestration • Sediment Management <p>Demonstration</p> <ul style="list-style-type: none"> • Innovation • Research and Development <p>Funding Potential</p> <ul style="list-style-type: none"> • Monetary Match • Available In-Kind Match Available Grant Program • Political Support

worksheet is provided in Appendix B). Each criteria was compared to the other 60 criteria. The scoring was as follows:

- If Criteria A (independent criteria) was more important than Criteria B (dependent criteria, i.e., one of the remaining 60 criteria), then Criteria A received a score of “1,” and Criteria B received a score of “0.”
- If the two criteria were of equal value, both criteria received a score of “0.5.”

While completing the worksheet, each criteria would have a turn at being the independent criteria.

In all cases the sum total of the mirror comparisons equal 1 (e.g., the cumulative score of criteria A compared to criteria B plus the score of criteria B compared to criteria A should always equal 1). The importance of this rule is that the order of the comparison has been found to occasionally effect how one perceives importance, thereby creating errors while completing the worksheet. To evaluate the 61 criteria, 3,660 comparisons were required, typically taking a full 3 to 5 hours to complete. Appendix B contains a copy of each individual worksheet completed for this screening effort.

Twenty-nine (29) individuals, representing CIB, various sections of DNREC, PDE, USFWS, Maryland Coastal Bay Program, TNC, DNS, Sovereign, and Cardno, were invited to complete the scoring exercise. Ten (10) worksheets were successfully completed and returned for analyses. Generally an error of +/- 20 scoring errors was acceptable. Copies of the raw scoring sheets and summaries are included in Appendix B. The names were removed from the scoring sheets for animosity purposes.

The cumulative results, from those who successfully completed the Worksheet, were presented to CIB and the results were discussed. Of the 12 categories, and their associated subcategories, the following 5 averaged 49 points out of 60 points or greater: Feasibility, Climate Change, Ecological Functions, Water Quality, and Special Interests (Table B2, Appendix B). The remaining categories averaged approximately 15 points, or more, lower. After discussion, the following decisions were made:

- The top five categories were selected for the Tier 2 Screening;
- Aesthetic Value and Demonstration categories were also selected for the Tier 2 Screening;
- Virtually every individual scoring the Worksheet identified a similar set (five) of high importance categories, demonstrating strong and universal interest. As such, these categories were given a 2x weighting to the scoring matrices in order to carry the elevated interest through the scoring process; and
- The scoring matrices would be developed based upon the higher scoring subcategories topics for each selected category.

Based upon the decisions noted above, a scoring matrix was developed for each of the selected criteria. Table 1 provides the framework of the matrices. Exhibit 4 provides an example of one of the criteria scoring matrices. A complete set of scoring matrices is found in Appendix B.

Table 1. Scoring Matrices Framework

Criteria	Matrix Context Topics (MCT)	MCT Scoring Range	Total Criteria Scoring Range	Criteria Multiplier
Aesthetics	- Green (nature-based)	0 to 4	0 to 12	1X
	- Blending (integration with surroundings)	0 to 4		
	- Long-Term Aesthetics	0 to 4		
Feasibility	- Permitability	0 to 6	-4 to 10	2X
	- Project Cost	-3 to 0		
	- O&M (need/probability)	-1 to 4		
Climate Change (need based)	- Sea Level Rise	0 to 3	1 to 19	2X
	- Acute Severe Weather	1 to 8		
	- Flood Mitigation	0 to 5		
	- Resilience	0 to 3		
Ecological Functions (potentials)	Ecological Uplift (8 areas considered)	0 to 20	0 to 20	2X
Water Quality (potentials)	Nutrient Reduction/Processing - Carbon Sequestration - Sediment Management	0 to 20	0 to 20	2X
Demonstration (potentials)	Innovation	0 to 5	-2 to 9	1X
	Research & Development	-2 to 4		
Special Interests	Ownership	0 to 9	0 to 30	2X
	Special Interest Sites	0 to 6		
	Dredge Reuse Potential	0 to 3		
	Funding Support	0 to 12		
Grand Total Scoring Range with Multipliers: -10 to 219				

EXHIBIT 4 EXAMPLE CRITERIA SCORING MATRIX									
FEASIBILITY									
Scoring Context:	<i>Permitability (additive):</i>	<i>Heavy Equipment (additive):</i>	<i>Expected O&M is:</i>						
- Permitability	Less than 500 ft. (NWP13): 2	Heavy equipment access	100% natural area: 4						
- Project Cost	Likely above MLW (WSLS): 2	by water only: -1	On a highly maintained private property: 3						
- O&M (need/probability)	> 50 ft. from Nav. Channel: 2	Project < 100 ft. (higher cost per linear ft.): -1	On unmaintained public/private property: 2						
		Access through natural areas (requiring restoration): -1	On community open space: 2						
			Undetermined: 1						
			Easily accessible by the general public: -1						
Total x 2:	6 4 2 0	0 -1 -2 -3	4	3	2	1	-1		

The range of possible points for the Tier 2 Screening was -10 to 219 points. Under the supervision of the Project Team’s senior restoration ecologist, the Project Team’s GIS/CAD drafter who performed the Tier

1 Screening also performed the Tier 2 Screening. The scores ranged from 55 to 138 points, with the mean score being 92 points. When performing this type of screening, in addition to having the matrices address the criteria appropriately, the screening results should have a wide and balanced distribution. A proper distribution of screening scores allows for better priority site selection and demonstrates proper criteria selection and evaluation. A simple evaluation of the data set (screening scores) is to run a standard deviation (SD) plot and associated plot curve (Figure 2). The SD plot was strongly representative of the “ideal distribution” bell curve and was spread over more than 4 SDs, suggesting effective matrices development and scoring.



Picture 1. Part of the Technical Team during the site visits.

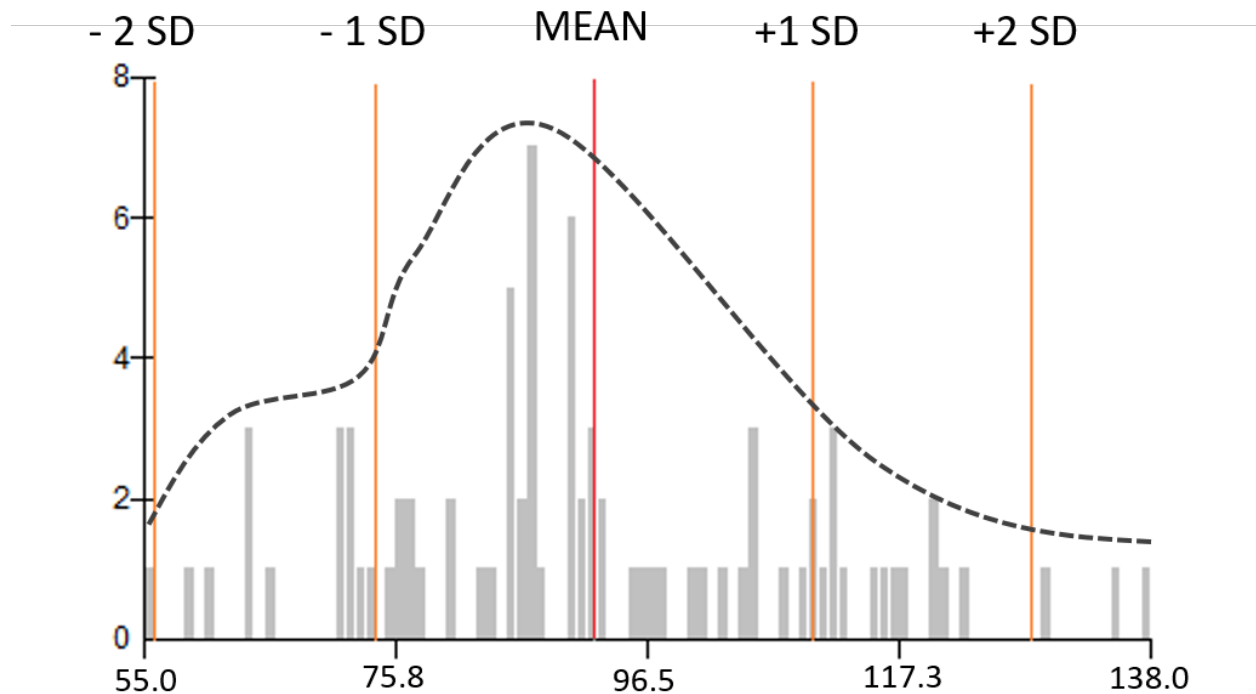

Figure 2. Standard Deviation Plot and Curve of the Tier 2 Screening Scores.

The sites were ranked by score, and the Tier 2 Screening results were presented to the CIB. Following the presentation of results, the CIB discussed the results internally. Among the higher scoring sites, the CIB identified which sites represented the best interests and opportunities for the CIB to implement demonstration living shoreline projects within the Bays. Considerations such as location, public interest, funding potential, outreach potential, target audiences, site distributions, etc. were included in the discussions. Ultimately 10 top priority sites were selected for site visits (Exhibit 5 and Appendix B, Figure B1).

The purposes of the site visits were to 1) ground truth the accuracy of the GIS interpretation during the scoring process, and 2) provide the technical team an opportunity to discuss options for living shoreline tactics. The site visits occurred on August 26, 2016. The site visit team consisted of: CIB's Science and Restoration Coordinator, Education and Outreach Coordinator, and Program Manager; PDE's Science Director, and Sovereign's Senior Restoration Ecologist, who would be managing the concept designs on the final selected sites.

Immediately following the last site visit, the Technical Team discussed each site and came to a mutual agreement on the top 6

sites: Inlet Road East, VFW at Quillens Point, Swann Keys, Angola by the Bay, Shell Landing Cove, and Dewey Beach at Sunset Park. These top 6 site proceeded to the concept design phase of the project.

EXHIBIT 5
CIB's Top 10 Priority Sites*

<u>Site</u>	<u>Ownership</u>	<u>Bay</u>
Inlet Road East	State	RB
VFW, Quillens Point	Private	IRB
SeaTown	HOA	LAB
Swann Keys	HOA/State	LAB
The Refuge (Leisure Drive)	Private	LAB
DE Botanic Gardens, Pepper Cr.	Private	IRB
Oak Orchard Lots 136 - 141	Private	IRB
Angola by the Bay	HOA	RB
Shell Landing Cove	HOA	RB
Dewey Beach, Sunset Park	Town	RB

*Site names in bold indicates their selection for concept designs

PART 2 – CONCEPT DESIGN EFFORT

The majority of the concept design effort is presented in Appendix C, which contains the 6 concept design plan sets. The narrative below provides a brief summary of the design effort. The design effort had multiple goals focusing on demonstration and innovation, including:

- 1) The tactics incorporated into the design efforts should include innovative techniques to the Bays Region and/or State, or be new modifications to previously existing tactics;
- 2) When appropriate, the designs would apply tactics in different configurations dependent upon wave energy vectors;
- 3) Designs needed to be appropriate for the energy regime (e.g., low, medium, high) present at the site;
- 4) The designs were to be located throughout the shoreline cross section, that is, from high tide to subtidal (including shallow reefs to protect and enhance the shorelines); and
- 5) Living shoreline solutions were to be developed that do not disrupt existing ecosystem services and are acceptable to the landowner.

Preliminary cost estimates are provided following each project description. The cost estimates are contractor implementation cost estimates and do not include costs or efforts associated with CIB. The costs incorporate permitting fee, mobilization/demobilization, materials, manufacturing, deployment, and associated labor. These costs do not include monitoring fees, public outreach, or landowner coordination by CIB. The project cost range was developed by creating a single point estimate and adding +/- 20 percent to that estimate. These costs assume market rates for materials, and do not consider volunteer support, free/low cost sand or sediment acquisition, or other opportunities for reduced costs and fees. IN addition, the cost estimates have the following assumptions:

- A permitting cost of \$6,600 was included for each estimate;

- A consultant cost of \$1,320, to support CIB with landowner coordination, was included for each project (excepting the more complicated Dewey Beach at Sunset Park Project);
- A mobilization/demobilization cost of \$4,400 was included for work requiring over water equipment (e.g., barges, cranes, hoppers, etc.); and
- Where sand fill is required, a unit rate of \$45 per cubic yard (delivered and placed) was used. Cost for fill is a highly variable cost that is often project specific.

The concept design efforts are summarized at the end of this section.

VFW at Quillens Point

The VFW site is located on the Quillens Point Peninsula, surrounded by water on three sides with different energy paradigms. The reach of shoreline selected was one of higher energy, and is experiencing erosion. The selected reach has a northern fetch of just under a one mile and a northwestern to west fetch of approximately 2.5 miles to more than 4 miles. The site is partially shelter from the east by low elevation land masses (marshes). Much of the water around the



Picture 2. VFW Site, beach showing relic structures.

point is shallow (wadable). Combining the fetch with depth, results in a low amplitude and wavelength waves hitting the shoreline at high frequencies, resulting in lateral shoreline and marsh erosion. Of the final six sites, only the Shell Beach Cove Site (discussed below) appeared to receive higher energy. Relic pilings, bulkheads, concrete debris, and tree trunks were also noted along portions of the shorelines.

The VFW site location is an ideal candidate for hybrid energy attenuation reef to reduce focused wave energy and promote natural accretion. Due to the vector angles, the reefs are not located parallel to the shoreline, but rather angled off the shoreline for maximum effectiveness balanced with reduced aesthetic impacts. The proposed tactic would be considered an *Energy Dissipating Living Shoreline* by the State and would require a basic

Subaqueous Lands Permit and/or Lease. The US Army Corps of Engineers (USACE) would be able to authorize this work under the NWP Program. A preliminary cost estimate is provided in Table 2.

As part of the proposed project, a low energy zone would be created between the reef and land, allowing for

Table 2. Cost Estimate VFW at Quillens Point

ITEM DESCRIPTION	COST
WADS (2' tall , 3.5' wide)	\$46,200
WADS (3.5' tall , 5.5' wide)	\$115,198
Marker Buoy (4)	\$990
Labor (Construction)	\$32,670
Labor (Permitting)	\$6,600
Labor (Construction Oversight)	\$7,722
Labor (Land Owner Coordination)	\$1,320
Mob/Demobilization	\$4,400
Total Cost	\$215,100
Cost Range +/- 20%	\$172,100 to \$258,100

passive accretions. However, if the proper dredge material would become available (e.g., potentially from the White Creek or Beach Cove areas), active nourishment using the dredged spoils could be placed in the low energy zone to “speed up” the desired sedimentation process.

To date, a meeting was held on December 2, 2016, with the VFW representatives to discuss the concept design. The concept was well received and further discussions are anticipated.

VFW Post 7234, www.vfw7234.com

Swann Keys

The Swann Keys site is located in a canal that is fully bulkheaded. Wind generated wave energy is low, and wave energy from boat wakes is also in the lower range. The site is affected by the tidal cycle, including blow-in tides.

The Swann Keys site offers a unique opportunity to demonstrate a nature-based water quality BMP tactic in a dead end lagoon. There is also untreated surface runoff entering the canal at the site. Certain residents in the community have generate local interest in living shoreline application for Swann Keys. This particular approach would involve replacing two



Picture 3. Before & After Renditions at Swann Keys

Table 3. Cost Estimate Swann Keys

ITEM DESCRIPTION	COST
Excavation	\$13,111
Bulkhead Removal	\$4,152
Gravel Diaphragm (incl. geoweb)	\$7,752
Kayak Ramp (incl. geoweb)	\$3,060
Turfgrass	\$980
Concrete Rubble	\$26,700
Oyster Shell	\$5,040
Geotextile	\$3,398
Topsoiling	\$1,548
Plantings (<i>Spartina alternifolia</i>)	\$9,750
Coir Fiber Log	\$3,529
Labor (Permitting)	\$6,600
Labor (Construction Oversight)	\$11,500
Labor (Land Owner Coordination)	\$1,320
Mob/Demobilization	\$7,903
Total Cost	\$106,343
Cost Range +/- 20%	\$85,100 to \$127,600

bulkheaded sides of the dead end canal with a band of marsh. The marsh band would eliminate future bulkhead maintenance costs, help filter water within the canal, improve treatment of surface water entering the canal, improve aesthetics, and provide habitat for wildlife. Sovereign worked with RK&K (subcontractor) to include certain stormwater treatment measures into the concept design.

Due to the mixed recycled concrete/shell toe revetment, the proposed tactic would be considered an *Armored*

Living Shoreline by the State and would require a basic Subaqueous Lands Permit and/or Lease. The USACE would be able to authorize this work under the NWP Program or an SPGP. A preliminary cost estimate is provided in Table 3.

The width of the marsh band is driven by the available funding. The current concept design has balanced the earthwork to reduce the need to bring in or remove material. The cost of the toe revetment is similar regardless of the thickness of the marsh band. Therefore, if a free source of the appropriate type of dredged material is identified, the thickness of the marsh band could potentially increase. This tactic has application throughout Delaware's canal systems.

To date, a meeting and presentation was held with the HOA Board on October 16, 2016, further coordination is anticipated to occur in 2017.

Swann Keys HOA, <http://swannkeys.org>

Angola by the Bay

The Angola by the Bay site is located on Burton Prong off of Herring Creek, where the water is brackish (i.e., mesohaline; 7 to 13 ppt. salinity). The lower salinity makes this site unique relative to the other selected sites. The fetch is less than 0.15 mile, and the shoreline is shallow. The substrate is predominantly muck and other fine sediments, suggesting that most of the prong's energy, other than wake energy, remains in the channel thalweg and away from the shoreline. The predominant energy associated with this site is due to flooding during large storm events and wake action of smaller vessel. The presence of dead woody vegetation, absence of live vegetation along portions of the shoreline, and lateral erosion suggest the presence of chronic wave (wake) energy and SLR stressors.



Picture 4. Angola by the Bay site near low tide.

The proposed innovation at this site involves the reinforcement (increased resilience) of an established *Conventional Living Shoreline* tactic by the incorporation of a hardwood log toe. In recent years, there has been an increased interest in the use of biochar and forms of activated carbon as a water quality BMP. To date, the vast majority of the application has occurred in freshwater environs, and little to no data exists on the effectiveness of this technology in waters having higher salinity. This concept design has included an optional research and development (R&D) component incorporating biochar. The biochar is expected to pull additional nutrients out of the water column and help the robustness of planted vegetation. The effectiveness of the biochar could be evaluated by collecting before and after soil samples tested for nutrients and by comparing established biomass in the treatment cells to the control cells. Additional implementation costs for this R&D component would be just under \$1,000, excluding monitoring costs.

The proposed tactic would be considered a *Conventional Living Shoreline* by the State and would require a Statewide Activity Approval for Shoreline Stabilization Projects in Tidal and Non-tidal Waters of the State of Delaware. The USACE would be able to authorize this work under the NWP Program. A preliminary cost estimate is provided in Table 4.

The proposed tactic has the potential for dredged material re-use. However, at the currently designed scale of the project, re-use application is economically limited due to the limited volume of required dredged spoil. Using this tactic in a larger scale or as a nature-based toe for island restoration within the lower energy tributaries of the Bays would increase dredged material re-use feasibility.

To date, a meeting was held onsite with members of the community during a site visit on August 26, 2016. Further coordination is anticipated to occur in 2017.

Angola by the Bay HOA, www.angolabythebay.org

Shell Landing Cove

Shell Landing Cove is part of the Bayfront at Rehoboth community, located along the western shoreline of Rehoboth Bay. The site has a northeast to east fetch of approximately two to the more than 3 miles. The northeast to east energy corridor is associated with coastal storms (tropical storms and nor'easters), making this site the highest energy site of the six selected sites. The fetch combine with this site being located on the western shore of the Rehoboth Bay makes it susceptible to blow in and stacked tides, which result in flooding and higher energy. The water depth is shallow (wadable) and the substrate is sandy. The site is a mixed beach and high quality marsh, both of which are being impacted by wave energy. There is currently a considerable amount of stone armoring at this site, having partial effectiveness against wave energy. There is interest in a more nature-based approach that may be able to replace a portion of the stone in its current condition. A hybrid reef offers protection to part of the marsh and the beach, but also will help the

Table 4. Cost Estimate Angola by the Bay

ITEM DESCRIPTION	COST
Heavy Duty Staples	\$28
Duckbill Anchor	\$535
10' Hardwood Log 12-15" Dia.	\$842
Coir Log 12" Dia. (10' Lengths)	\$1,672
4' x 2" x 2" Hardwood Stakes	\$580
3/8" Hemp Rope	\$54
1/4" Steel Cable	\$267
Labor (Construction)	\$26,136
Labor (Permitting)	\$6,600
Labor (Construction Oversight)	\$5,148
Labor (Land Owner Coordination)	\$1,320
Total Cost	\$43,182
Cost Range +/- 20%	\$34,600 to \$51,800



Picture 5. Shell Landing Cove, heavily armored with limited success.

marsh and beach edge to grow through accretion. Following the initial development of this concept design, an option was added providing for a more eco-friendly and aesthetic re-use of the stone present onsite, which could be performed after or concurrent with the reef creation. The concept design in Appendix C includes this re-use option. The cost estimate does not include this re-use option.



Picture 6. Shell Landing Cove, January 2016, severe marsh flooding (foreground), beach gazebo (background).

The proposed tactic would be considered an *Energy Dissipating Living Shoreline* by the State and would require a basic Subaqueous Lands Permit and/or Lease. The US Army Corps of Engineers (USACE) would be able to authorize this work under the NWP Program. A preliminary cost estimate is provided in Table 5.

As part of the proposed project, a low energy zone would be created between the reef and land, allowing for passive accretions. However, if the proper dredge material would become available (e.g., potentially from Herring Creek or Love Creek), active nourishment using the dredged spoils could be placed in the low energy zone to “speed up” the desired sedimentation process.

Table 5. Cost Estimate Shell Landing Cove

ITEM DESCRIPTION	COST
WADS (3.5' tall , 5.5' wide)	\$179,872
Marker Buoy (4)	\$1,485
Labor (Construction)	\$26,136
Labor (Permitting)	\$6,600
Labor (Construction Oversight)	\$6,006
Labor (Land Owner Coordination)	\$1,320
Mob/Demobilization	\$4,400
Total Cost	\$225,819
Cost Range +/- 20%	\$180,700 to \$271,000

In addition to meeting with community members during the site visit on August 26, 2016, a meeting was held on November 16, 2016 with the community’s task force established for the purpose of implementing this project.

Bayfront at Rehoboth HOA, www.bayfronthoa.net

Dewey Beach at Sunset Park

The Dewey Beach at Sunset Park is a site that extends approximately three blocks along the bayside shoreline of the Town of Dewey Beach. The site begins at Sunset Park/Head of Bay Cove and continues south to, and including, the McKinley Street Marsh. Review of historical photography suggests weak lateral drift of sediment, meaning the project area has a limited natural supply of sediments (poor resilience). The area has a southwest fetch of approximately 3.5 miles and a south-southwest fetch approaching 5 miles. Water depth near the shoreline is shallow (wadable), but shortly becomes deeper. Although the site is sheltered from most of the winter storm energy out of the north-northeast-east energy

corridor, the long fetch, slightly deeper water, and the low shoreline elevations (1.0 to 3.0 NAVD88) make this site vulnerable to storm energy, SLR, and frequent flooding.

This is a complicated site that will utilize multiple tactics, both hybrid and conventional, involve marsh enhancement, and integration with stormwater management planning. This effort is being coordinated between CIB, DeIDOT, DNREC, Sovereign, and RK&K who is subcontracted to the Town of Dewey Beach for stormwater planning. Tactics being

proposed include shallow reefs, hybrid living shorelines utilizing structural components, oyster shell bags, and sand nourishment (backfill). This concept design includes two reef configuration options. The more expensive option was used while preparing the preliminary cost estimate (Table 6).



Picture 7. Dewey Beach at Sunset Park, notice the erosions and loss of road.

The proposed tactic would be consider a Mixed Conventional/Hybrid Living Shoreline by the State and would require a basic Subaqueous Lands Permit and/or Lease. The USACE would be able to authorize this work under the NWP Program.

The proposed tactic requires sand or dredged material re-use. The material would be used to create marsh and beach habitats.

Coordination with the town was conducted through development of a NOAA grant proposal to support the project, and through an ongoing multi-partner Coastal Corridor initiative led by DeIDOT and the CIB.

Town of Dewey Beach,
www.townofdeweybeach.com

Inlet Road East

The Inlet Road East site is located along the north entrance road to the Indian River Inlet (IRI). It is in walking distance from the northern IRI camp grounds, the CIB office, and portions of the beach, and visible from Inlet Road East. The site receives moderate energy from the north-northwest corridor (maximum fetch approximately 0.3 mile) and receives wind-blown sand from the east during severe storm events. Observed evidence of

Table 6. Cost Estimate Dewey Beach at Sunset Park

ITEM DESCRIPTION	COST
WADS (2' tall , 3.5' wide)	\$65,522
WADS (3.5' tall , 5.5' wide)	\$85,118
Marker Buoy	\$1,485
Concrete Discs	\$60,720
Oyster Bags	\$3,067
1/4" Nylon Rope	\$537
3' x 2" x 2" Hardwood Stakes	\$223
Sand Backfill	\$14,850
Shipping	\$2,200
Labor (Construction)	\$81,675
Labor (Permitting)	\$6,600
Labor (Construction Oversight)	\$17,160
Labor (Land Owner Coordination)	\$2,640
Mob/Demobilization	\$4,400
Total Cost	\$346,197
Cost Range +/- 20%	\$277,000 to \$415,400

loose plant material, scoured marsh peat, lateral shoreline erosion are indicators of excessive shoreline energy. The Inlet Road East site was originally identified to be well suited for a shallow oyster bag/oyster castle reef to attenuate wave energy and promote natural accretion. Once this energy attenuation tactics is implemented, the site could be a candidate for additional lower energy tactics in the upper portion of the tidal prism.



Picture 8. Inlet Road East with the CIB Program Manager.

The proposed tactic would be consider an *Energy Dissipating Living Shoreline* by the State and would require a basic Subaqueous Lands Permit and/or Lease. The USACE would be able to authorize this work under the NWP Program. A preliminary cost estimate is provided in Table 7.

As part of the proposed project, a low energy zone would be created between the reef and land, allowing for passive accretions. However, if the proper dredge material would become available (e.g., potentially from Indian River Inlet Marina), active nourishment using the dredged spoils could be placed in the low energy zone to “speed up” the desired sedimentation process.

After the initial concept design was developed, the

CIB reevaluated this site and a decision was made not to support a demonstration project at this location. The barrier strip, located immediately adjacent to the site, is viewed by CIB to be vulnerable to ocean-side energy from extreme storms. Because of this, the site was considered not to be appropriate for a stand-alone living shoreline demonstration.

However, the concept design is still included in this report. The concept design tactic could be used at other locations along the Bay shoreline. Alternatively, if other partners, such as the Delaware Department of Transportation, choose to do additional work to make the current site location and adjacent highway more resilient to hurricanes and other extreme storms, this living shoreline design could potentially be incorporated as a component of that project.

Delaware State Parks

Table 7. Cost Estimate Inlet Road East

ITEM DESCRIPTION	COST
Oyster Bags	\$2,145
Oyster Castles	\$635
Coir Mat90	\$1,234
Duckbill Anchor	\$2,534
Hammer Probe w/ Ext.	\$561
1/4” Nylon Rope	\$2,728
Perishable Materials/Rentals	\$1,760
Shipping	\$275
Labor (Construction)	\$29,700
Labor (Permitting)	\$6,600
Labor (Construction Oversight)	\$4,455
Labor (Land Owner Coordination)	\$1,320
Total Cost	\$53,947
Cost Range +/- 20%	\$43,200 to \$64,700

Cost Estimates and Benefits

Table 2 provides estimated costs for the conceptual designs, as both total cost and cost per linear foot of shoreline protected. Table 2 also provides a brief summary of gross ecological benefits. The ecological benefits are presented relative to habitat improvements and increased resilience, and are expressed in changes in area or linear feet of shoreline affected.

In 2014, The Chesapeake Bay Partnership’s Expert Panel (Panel) on Shoreline Management reviewed the science and developed protocols to estimate the nutrient pollutant load reductions associated with different shoreline management practices (*Approved version: http://chesapeakestormwater.net/wp-content/uploads/dlm_uploads/2015/10/Shoreline-Management-Protocols_Final_Approved_07132015-WQGIT-approved.pdf*). Estimation of anticipated pollutant load reductions from living shoreline projects is challenging, as each project is unique, and multiple processes impact loads. Following landowner agreement and any associated design revisions, estimates of water quality benefits would be made following the CBP protocols to estimate nitrogen and phosphorus load reductions due to four processes: (1) denitrification; (2) prevented sediment loss; (3) sediment capture; and (4) nutrient uptake by marsh vegetation. The Panel is also developing nutrient reduction protocols associated with oyster reefs and/or the incorporation of recycled shell. Once these protocols are finalized, it is intended to use these protocols as well when calculating nutrient/sediment reductions. These calculation would be prepared for funding opportunities and permit acquisition.

Table 8. Demonstration Living Shoreline Site Summaries

Consideration	VFW at Quillens Point	Swann Keys, Alt 3	Angola by the Bay	Shell Landing Cove (reef only)	Dewey Beach at Sunset Park	Inlet Road East
Habitat Benefits						
Marsh Edge Protected (LF)	405	---	88	527	1,013	---
Beach Protected (LF)	248	---	---	125	200	200
Armored Edge Protected (LF)	---	---	---	75	506	---
Armored Edge Removed (LF)	---	346	---	---	---	---
High Energy Area Conversion to Low Energy Area (AC)	2.1	---	0.04	1.9	5.8	0.18
Creation of Accretion Zones (AC)	2.1	---	---	1.9	5.8	0.18
Reef Habitat Created (SF)	4,895	---	---	4,928	3,671	168
Marsh Edge Created (SF/LF)	---	32,670/346	1,742/88	---	605/1013	---
Cost Estimate Range (\$1,000)	172 to 253	\$85 to \$128	35 to 52	187 to 271	277 to 415	43 to 65
Cost Per Linear Foot of Shoreline Affected (\$)	264 to 388	246 to 369	392 to 580	257 to 373	161 to 241	215 to 325

PART 3 – DREDGE MATERIAL RE-USE

Most hybrid and many conventional living shorelines can utilize dredge spoils, provided the dredged material has the proper characteristics. In the Tier 1 screening process, 44 demonstration sites were identified within 4,000 feet of State dredging projects. The 4,000 foot cutoff is based upon the physical limitations of the dredging equipment used by the State. The dredging project listing and 4,000 foot distance were provided by DNREC-Shoreline and Waterway Management Section personnel.

In 2007, re-use opportunities were identified in the DNREC publication entitled, *Sediment Management Plan, Rehoboth Bay, Sussex County, Delaware*. In this document, dredge material re-use was discussed. A number of concepts were presented, which included island restoration, marsh restoration, beach nourishment. Most of these concepts also involve some element of hard armoring, and often plantings in the background. A number of these concepts would be considered a form of living shoreline under today's standards. The tactics provided herein are of a more nature-based approach. This report should be used as a companion document offering more sites, more tactics, and more opportunities for dredged material re-use.

The scoring of the potential re-use sites generally followed the same trends as the relative to scoring. Figure 3 and Table 3 provides a listing of the potential living shoreline demonstration sites that are within the 4,000 linear foot capture zones. As noted in Part 1, a geospatial database was developed as part of this effort, which contains additional site information such as parcel number, ownership information, etc. Also, aside from the selected demo sites, no property owners were contacted, or agreed to have a project on their property.

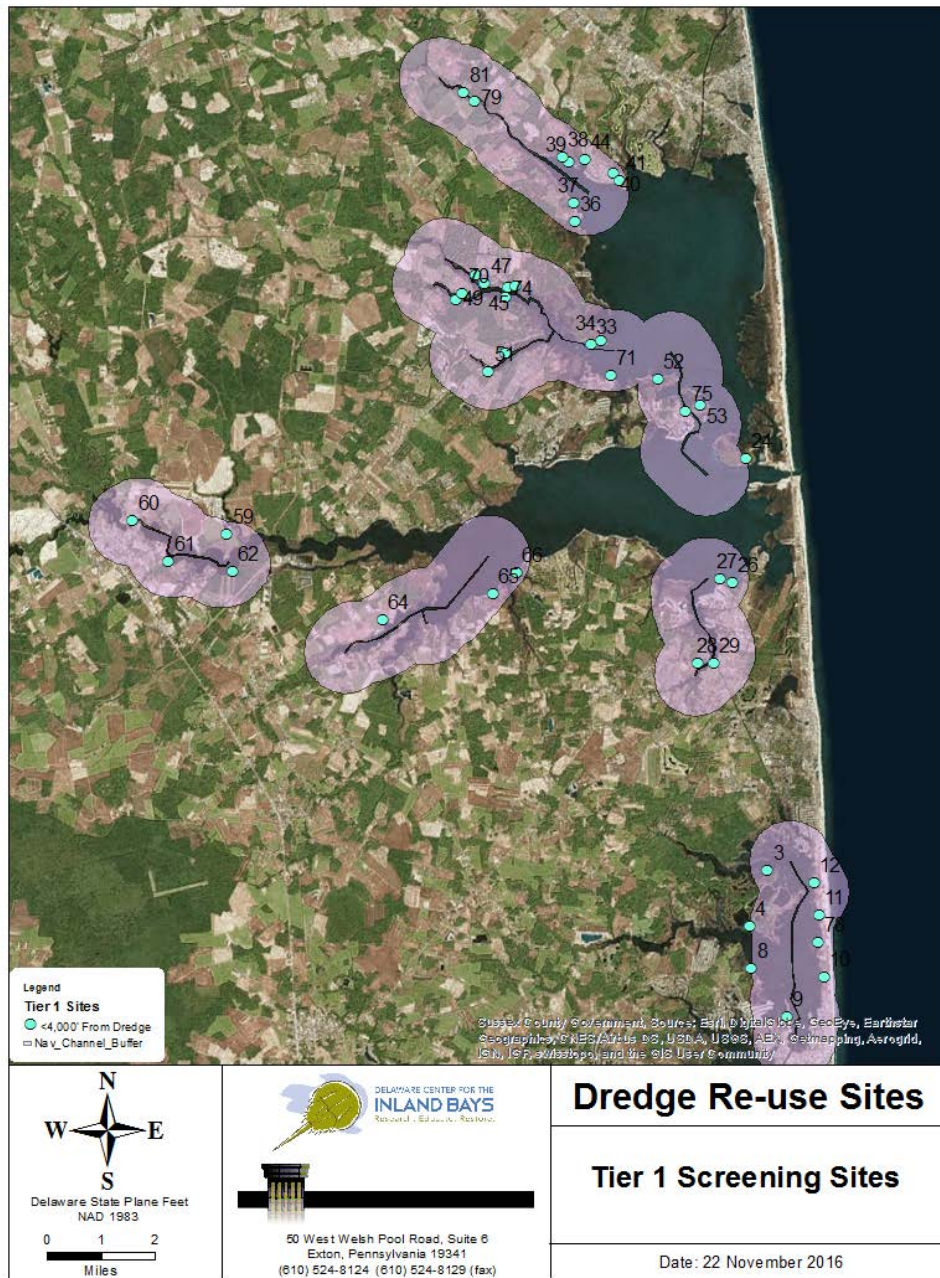

Figure 3. Dredge Re-Use Living Shoreline Demonstration Sites

Table 9. Listing of Identified Dredge Re-Use Demonstration Living Shoreline Sites

Mappe d Site ID	Site Name	Ownership	Coordinates		Overall Tier 2 Screenin g Rank	Tier 2 Screenin g Score
			POINT_ X	POINT_ Y		
34	Herring Landing	State	-75.1279	38.6438	3	129
28	Banks Marina	Private, Organization	-75.0953	38.5568	4	123
8	Ashlyn Rd	Private, Individual	-75.0774	38.4745	6	120
53	Raccoon Cove Is	Private, Individual	-75.0941	38.6264	7	120
24	Burton island IRI	State	-75.0786	38.6117	9	117
27	Patures Point	Local Government	-75.0875	38.5794	11	115
48	Angola 5	Private – Mult. Owners	-75.1711	38.6615	12	113
39	East Lane	Private, Individual	-75.1390	38.6917	17	110
71	Lingo Cove	Private, Individual	-75.1248	38.6345	18	110
33	Herring Landing west	Private, Individual	-75.1316	38.6427	21	105
49	Angola 10	Private, Individual	-75.1777	38.6547	22	105
78	Seatown	Private - HOA	-75.0543	38.4816	27	100
46	Angola 2	Private - HOA	-75.1602	38.6582	28	98
50	West Island Rd	Private, Individual	-75.1610	38.6406	32	93
37	Hunt Club Rd	State	-75.1372	38.6807	35	92
40	Marina Dr.	Private, Individual	-75.1235	38.6887	36	92
59	WWTP 1	Private, Individual	-75.2566	38.5918	37	91
61	Iron Branch Rd	Private – Mult. Owners	-75.2767	38.5844	38	91
11	Rt. 1 Access 2	Private, Individual	-75.0541	38.4890	39	90
36	Horse Island east	Private, Individual	-75.1371	38.6758	40	90
44	Old Landing GC	Commercial	-75.1335	38.6925	41	90
51	Gadwall Dr.	Private, Individual	-75.1669	38.6355	42	90
65	Peacock Point	Private – Mult. Owners	-75.1655	38.5757	44	90
60	Millsboro 1	Private – Mult. Owners	-75.2891	38.5956	45	88
10	Rt. 1 Access 3	State	-75.0524	38.4720	47	87
12	Rt. 1 Access 1	State	-75.0558	38.4976	48	87
29	Elliot Ave	State	-75.0899	38.5568	51	87
41	Henderson Dr. west	Private, Individual	-75.1215	38.6869	52	87
45	Angola 1	Private – Mult. Owners	-75.1574	38.6585	53	86
3	Strawberry Landing	State	-75.0716	38.5009	55	85
4	Mulberry Landing	State	-75.0778	38.4858	56	85
64	Timmons Cove	Private – Mult. Owners	-75.2033	38.5687	59	85
79	Webbs Landing - Farm	Private - Individual	-75.1713	38.7084	63	80
9	Lighthouse Cove west	Private - Individual	-75.0653	38.4615	67	76
62	Pebble Dr.	Private - HOA	-75.2549	38.5820	69	75
74	Herring Creek	Private – Mult. Owners	-75.1608	38.6556	70	74
81	Britz	Private - HOA	-75.1751	38.7106	71	73
26	Pastures Cove	Private – Mult. Owners	-75.0833	38.5786	72	72
66	Seagrass Plantation Ln	Private – Mult. Owners	-75.1574	38.5812	73	72
70	Angola 8	Private – Mult. Owners	-75.1756	38.6564	76	71
52	Nats Cove	Private – Mult. Owners	-75.1086	38.6332	78	65
38	West Lane	Private – Mult. Owners	-75.1412	38.6933	79	64
47	Angola 4	Private – Mult. Owners	-75.1680	38.6592	80	64
75	Massey Landing	State	-75.0990	38.6247	84	55

SUMMARY AND DISCUSSION

This report described an objective and reproducible approach for screening the tidal portion of the Bays system for living shoreline demonstration projects. The effort involved discussions, coordination, and/or support from the entire Delaware living shoreline community, including the CIB, SCD, DNREC, PDE, USFWS, TNC, the Delaware Living Shoreline Committee, municipalities, and the private sector (individuals and HOAs). New Jersey DEP expressed interest in the screening process, while DelDOT and the Town of Dewey Beach has expressed interest in the screening results prior to the completion of this project, demonstrating the pertinence of this work.

This project also identified feasibility, climate change, ecological functions, water quality, and special interests as the universal criteria when considering sites for living shorelines. Aesthetics and demonstration potential were identified as relevant criteria as well. This screening approach is a “living” model that can be added to or modified as needed in the future.

Six concept designs, located throughout the Bays, have been developed involving tactics new or unique to the Bays. Each concept design site has a unique energy regime. The tactics developed herein can be applied to other sites having similar characteristics within the Bays.

The 84 sites identified in this report may be combined or individually expanded to suit current or future project size needs and to match available funding. The dredged material re-use potential in the Bays is high. Nearly all the tactics presented in this report can presently, or readily be modified to, accept small to large dredged material volumes.

Appendix A

Tier 1 Screening

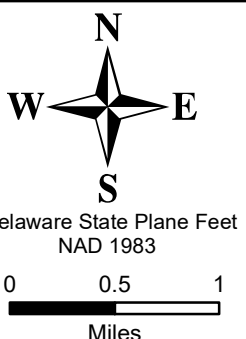

DELAWARE CENTER FOR THE
INLAND BAYS
Research. Educate. Restore.

SOVEREIGN CONSULTING INC.

50 West Welsh Pool Road, Suite 6
Exton, Pennsylvania 19341
(610) 524-8124 (610) 524-8129 (fax)

Figure A1

**Rehoboth Bay
Tier 1 Screening Sites**

Date: 22 November 2016



Legend
 Tier 1 Screening Sites

Sussex County Government, Source: Esri, DigitalGlobe, GeoEye, Earthstar Geographics, CNES/Airbus DS, USDA, USGS, AEX, Getmapping, Aerogrid, IGN, IGP, swisstopo, and the GIS User Community



Delaware State Plane Feet
 NAD 1983

0 0.75 1.5
 Miles



DELAWARE CENTER FOR THE
INLAND BAYS
 Research. Educate. Restore.



SOVEREIGN CONSULTING INC.

111-A North Gold Drive
 Robbinsville, New Jersey 08691
 (609) 259-8200 (609) 259-8288 (fax)

Figure A2

**Indian River Bay
 Tier 1 Screening Sites**

Date: 22 November 2016



Legend
 Tier 1 Screening Sites

Sussex County Government, Source: Esri, DigitalGlobe, GeoEye, Earthstar Geographics, CNES/Airbus DS, USDA, USGS, AEX, Getmapping, Aerogrid, IGN, IGP, swisstopo, and the GIS User Community



Delaware State Plane Feet
 NAD 1983

0 0.275 0.55
 Miles



DELAWARE CENTER FOR THE
INLAND BAYS
 Research. Educate. Restore.



SOVEREIGN CONSULTING INC.

50 West Welsh Pool Road, Suite 6
 Exton, Pennsylvania 19341
 (610) 524-8124 (610) 524-8129 (fax)

Figure A3

**Little Assawoman Bay
 Tier 1 Screening Sites**

Date: 22 November 2016

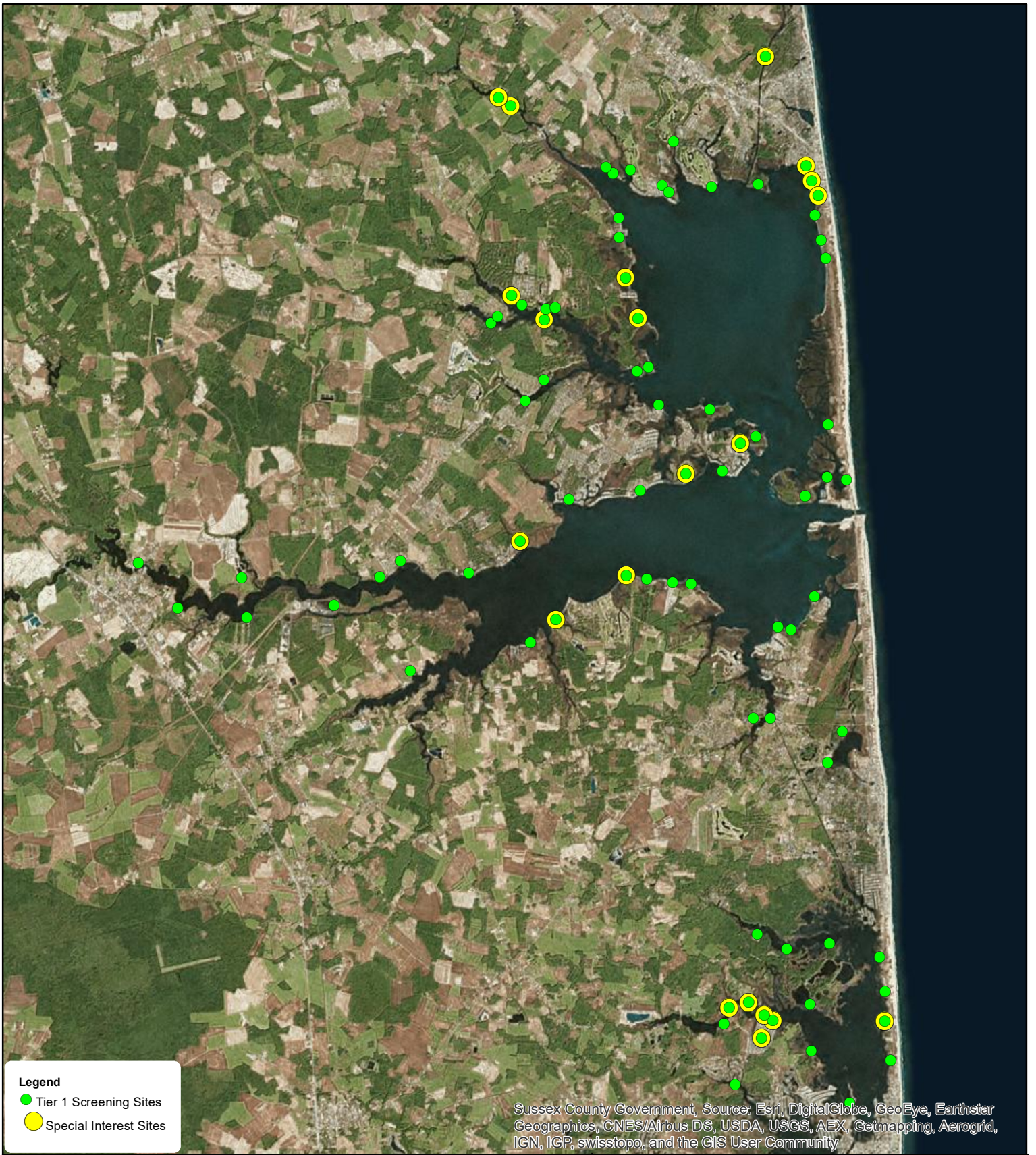

Sussex County Government, Source: Esri, DigitalGlobe, GeoEye, Earthstar Geographics, CNES/Airbus DS, USDA, USGS, AEX, Getmapping, Aerogrid, IGN, IGP, swisstopo, and the GIS User Community

Legend
 ● Tier 1 Screening Sites
 ● Special Interest Sites

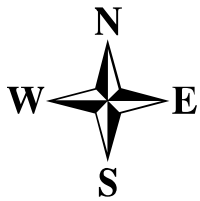

Delaware State Plane Feet
 NAD 1983

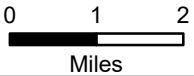

DELAWARE CENTER FOR THE
INLAND BAYS
 Research. Educate. Restore.

SOVEREIGN CONSULTING INC.

50 West Welsh Pool Road, Suite 6
 Exton, Pennsylvania 19341
 (610) 524-8124 (610) 524-8129 (fax)

Figure A4

Special Interest Sites Tier 1 Screening Sites

Date: 22 November 2016

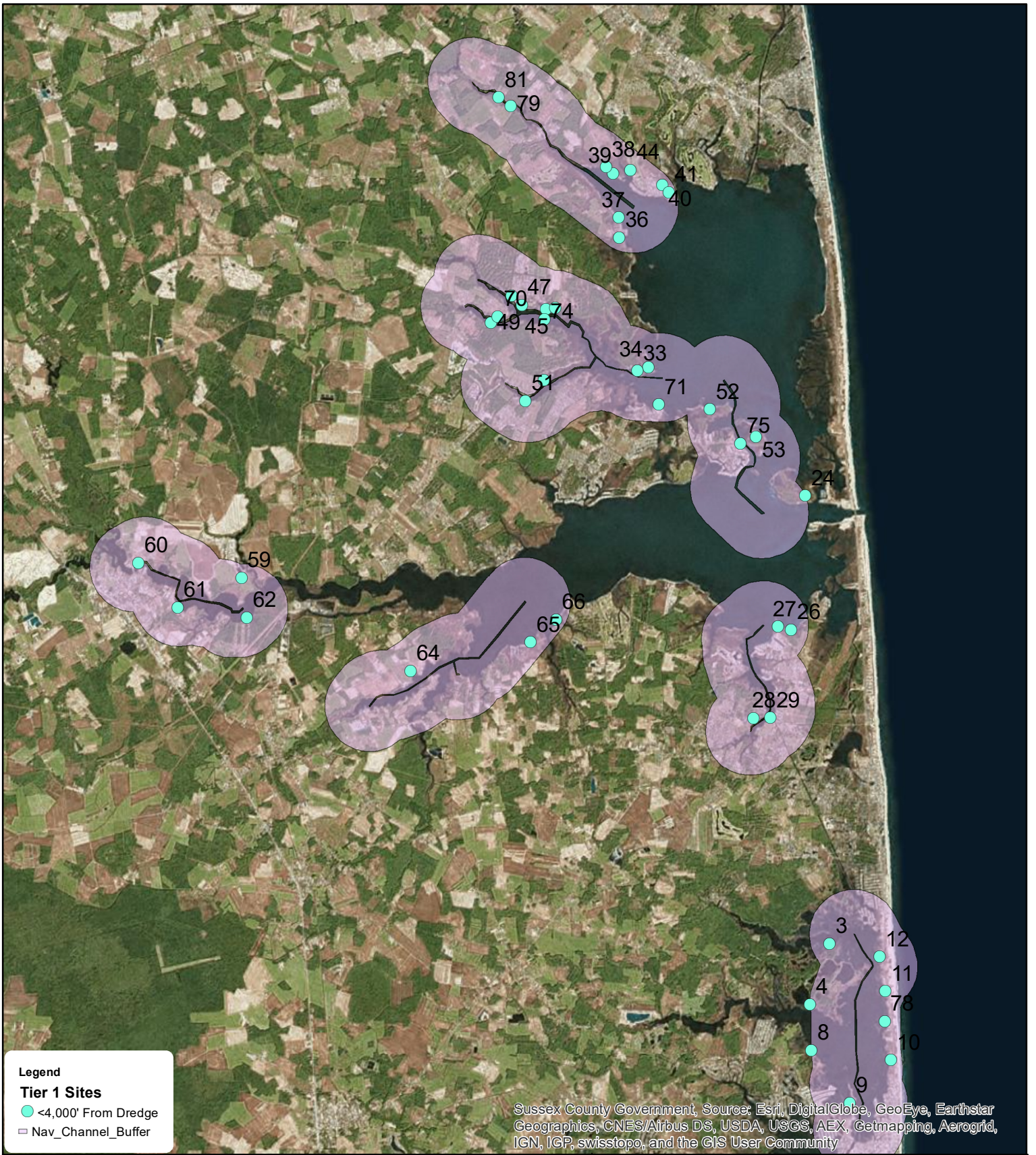

Legend
Tier 1 Sites
 ● <4,000' From Dredge
 □ Nav_Channel_Buffer

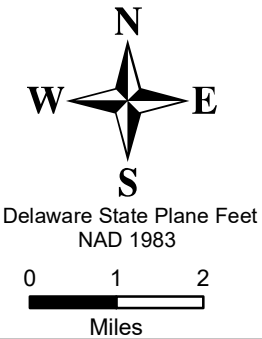

DELAWARE CENTER FOR THE
INLAND BAYS
 Research. Educate. Restore.

SOVEREIGN CONSULTING INC.

50 West Welsh Pool Road, Suite 6
 Exton, Pennsylvania 19341
 (610) 524-8124 (610) 524-8129 (fax)

Figure A5

**Tier 1 Screening Sites
 Within 4,000 Feet of
 State Dredging Projects**

Date: 22 November 2016

Appendix B

Tier 2 Screening

Appendix B

Mixed-Pair Comparison Test Completed Criteria Scoring Worksheets

Table B3 - Tier 2 Living Shoreline Demonstration Site Screening - Scoring Matrices

Site Location: _____

Date: _____

Scorer: _____

AESTHETIC VALUE																	
Scoring Context:	<i>Green opportunity:</i>				<i>Surroundings are:</i>				<i>Land use is/has:</i>								
- Green (nature-based)	Full opportunity for green design: 4				Predominately green: 4				Stable: 4								
- Blending (integration with surroundings)	Structure (<30%) present, green retrofit design: 3				Mixed developed/green: 3				Undetermined: 2								
- Long-Term Aesthetics	Structure (30-60%) present, limiting green options: 2				Developed & maintained: 2				Abandoned/unmaintained: 1								
	Structured (> 60%), severely limiting options: 0				Primarily delapidated: 0				Developmental pressure: 0								
Total x 1:	4	3	2	0	4	3	2	0	4	2	1	0					
FEASIBILITY																	
Scoring Context:	<i>Permitability (additive):</i>			<i>Heavy Equipment (additive):</i>				<i>Expected O&M is:</i>									
- Permitability	Less than 500 ft. (NWP13): 2			Heavy equipment access by water only: -1				100% natural area: 4									
- Project Cost	Likely above MLW (WLSL): 2			Project < 100 ft. (higher cost per linear ft.): -1				On a highly maintained private property: 3									
- O&M (need/probability)	> 50 ft. from Nav. Channel: 2			Access through natural areas (requiring restoration): -1				On unmaintained public/private property: 2									
								On community open space: 2									
								Undetermined: 1									
								Easily accessible by the general public: -1									
Total x 2:	6	4	2	0	0	-1	-2	-3	4	3	2	1	-1				
CLIMATE CHANGE (need based)																	
Scoring Context:	<i>SLR Susceptability:</i>				<i>ASW Vulner. (additive):</i>				<i>Flood Mitigation (additive):</i>			<i>Resilience (additive):</i>					
- Sea Level Rise	Average elevation w/in 50 ft.:				Site faces to the NNW to E: 3				Structure/infrastructure is:			Site has no obvious energy					
- Acute Severe Weather	of shoreline < 1ft AMSL: 3				Site faces ESE to SSW: 2				within 25 ft. of shoreline: 3			for sediment transport					
- Flood Mitigation	of shoreline 1- 2ft AMSL: 2				Site faces SW to NW: 1				25 to 50 ft. of shoreline: 1			or lateral drift (per AP): 2					
- Resilience	of shoreline 2- 3ft AMSL: 1				Fetch 1,000 - 2,000 ft.: 1				at an elev. < 2 ft. AMSL: 2			Not adjacent to a marsh: 1					
					Fetch > 2,000 ft.: 2				at an elev. 2-4 ft. AMSL: 1								
Total x 2:	3	2	1	0	8	7	6	5	4	3	2	1	0	3	2	1	0

Table B3 - Tier 2 Living Shoreline Demonstration Site Screening - Scoring Matrices

ECOLOGICAL FUNCTIONS (potentials)																				
Scoring Context: <i>Ecological Uplift</i>		<i>Is there a realistic potential for ecological function uplift for (additive):</i>																		
		Marshes?: 3							Submerged Aquatic Vegetation?: 2											
		Shellfish?: 3							Shorelines?: 3											
		Nekton?: 2							Horshore Crabs?: 2											
		Habitat Structure?: 3							Shorebirds?: 2											
Total x 2:		20	18	17	16	15	14	13	12	11	10	9	8	7	6	5	4	3	2	0
WATER QUALITY (potentials)																				
Scoring Context: <i>Nutrient Red./Process. Carbon Sequestration Sediment Management</i>		<i>Is there a realistic potential for :</i>																		
		Marsh enhancement/creation for nutrient reduction/processing, carbon sequestration, and sediment management?: 5																		
		Shoreline/bank enhancement/stabilization for sediment management?: 5																		
		Shellfish enhancement for nutrient reduction/processing and sediment management?: 3 or 5																		
		Activated carbon or similar (e.g., biochar) application and/or stormwater discharge quality?: 3 or 5																		
Total x 2:		20	18	16	15	13	11	10	8	6	5	3	0							
DEMONSTRATION (potential)																				
Scoring Context: <i>Innovation Research & Development</i>		<i>Innovation (additive):</i> Highly visible, societally important area: 3 Industrial/commercial or lower visibility area: 2				<i>Research & development (additive):</i> High human traffic area: -2 Limit or restricted access: 2 On Public lands: 2														
Total x 1:		5	3	2	0	4	2	0	-2											
SPECIAL INTERESTS																				
Scoring Context: <i>Ownership Special Interest Sites Dredge Reuse Potential Funding Support</i>		<i>Ownership (additive):</i> Private Ownership: 3 Public Highly Visible: 3 Known/agreed to access: 3				<i>Special interest (SI) (additive):</i> CIB SI: 2 DNREC SI: 2 Other SI: 2				<i>Dredge re-use potential:</i> Within 4,000 of a State dredging project, which is: Planned w/in 3 yrs: 3 Planned w/in 3+ yrs: 1			<i>Funding support (additive):</i> Known monetary match: 5 Known In-kind match: 3 Known political support: 4							
Total x 2:		9	6	3	0	6	4	2	0	3	1	0	12	9	8	7	5	4	3	0

GRAND TOTAL: 0



Sussex County Government, Source: Esri, DigitalGlobe, GeoEye, Earthstar Geographics, CNES/Airbus DS, USDA, USGS, AEX, Getmapping, Aerogrid, IGN, IGP, swisstopo, and the GIS User Community

Legend

- Tier 2 top 6 Sites
- Tier 2 Top 10 Sites

Delaware State Plane Feet
NAD 1983

Miles

DELAWARE CENTER FOR THE
INLAND BAYS
Research. Educate. Restore.

SOVEREIGN CONSULTING INC.

50 West Welsh Pool Road, Suite 6
Exton, Pennsylvania 19341
(610) 524-8124 (610) 524-8129 (fax)

Figure B1

**Top 10 Sites
Tier 2 Screening**

Date: 22 November 2016

Appendix C

Concept Designs

Dewey Beach, Sunset Park

VFW

Swann Keys

Angola by the Bay

Shell Beach Landing

Inlet Road

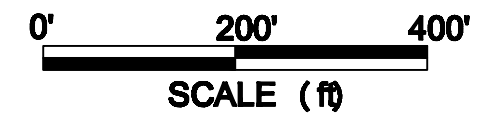
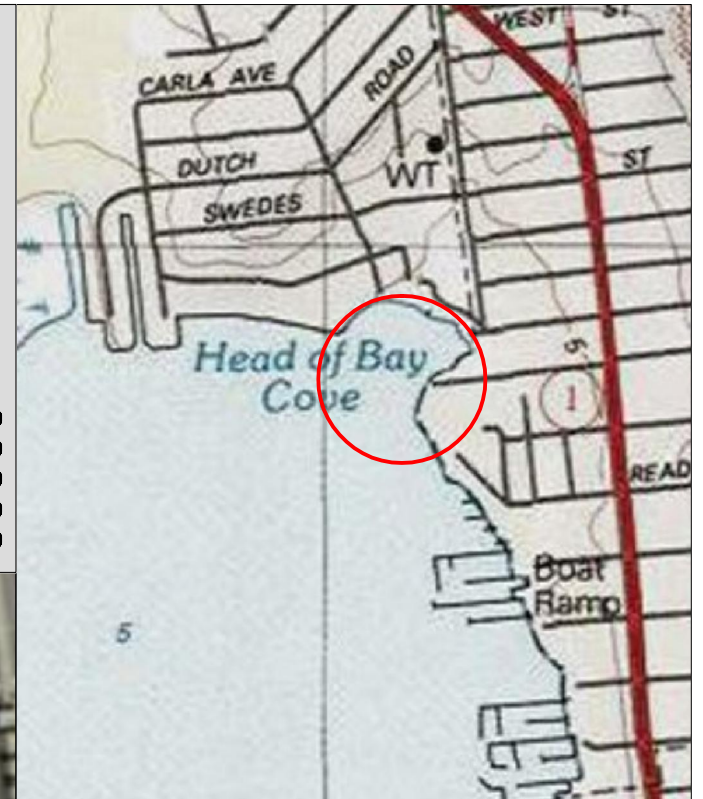

DEWEY BEACH SUNSET PARK 101 DAGSWORTHY STREET DEWEY BEACH, DELAWARE 19971		
EXISTING CONDITIONS PROJECT AREA		
DELAWARE CENTER FOR THE INLAND BAYS 39375 Inlet Road, Rehoboth Beach, DE 19971 (302) 226-6106 www.inlandbays.org		
SOVEREIGN CONSULTING INC. 50 West Welsh Pool Rd., Suite 6 Exton, Pennsylvania 19341 (610) 524-6124 www.sovcon.com		
Created By: DJS	Original: 11/14/16	Figure: 1.0
Revision Date	By	
11.22.16	DJS	
Sheets Affected		
ALL		

Sussex County Government, Source: Esri, DigitalGlobe, GeoEye, Earthstar Geographics, CNES/Airbus DS, USDA, USGS, AEX, Getmapping, Aerogrid, IGN, IGP, swisstopo, and the GIS User Community, Esri, HERE, DeLorme, MapmyIndia, © OpenStreetMap contributors

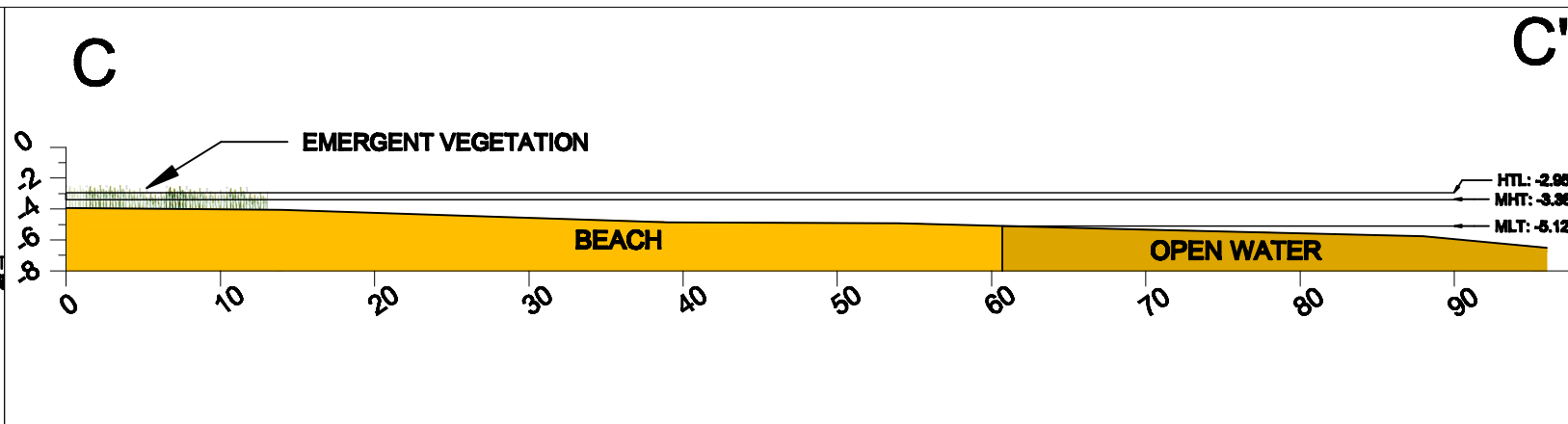
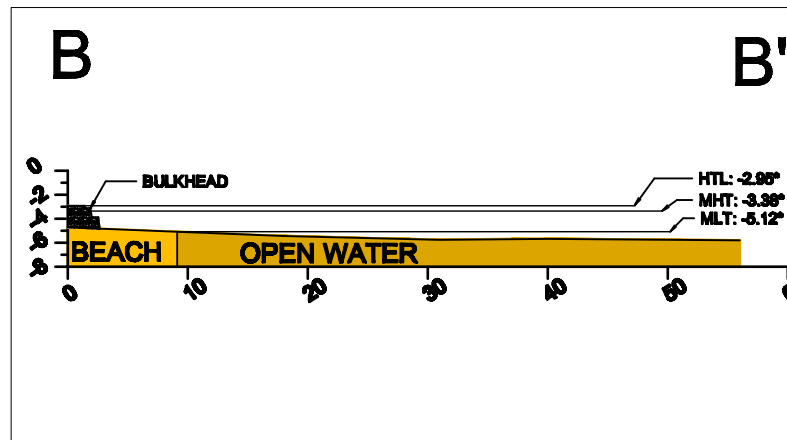
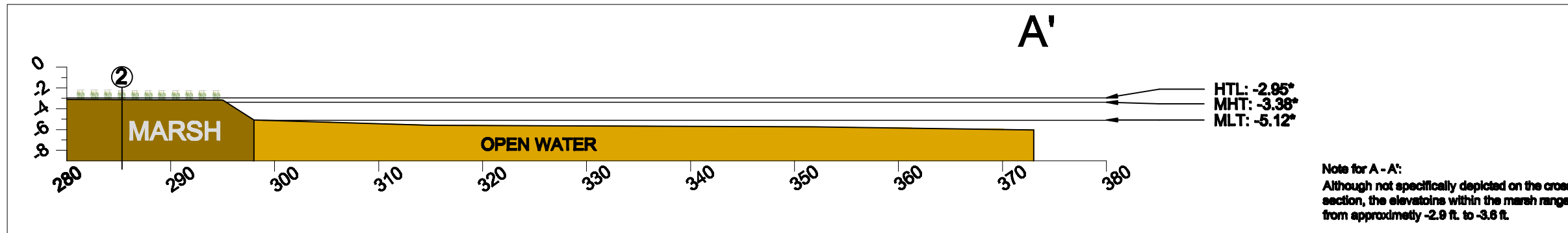
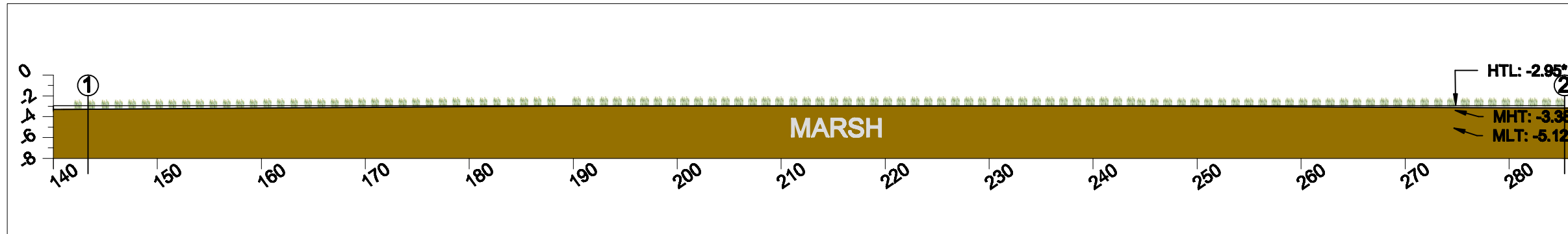
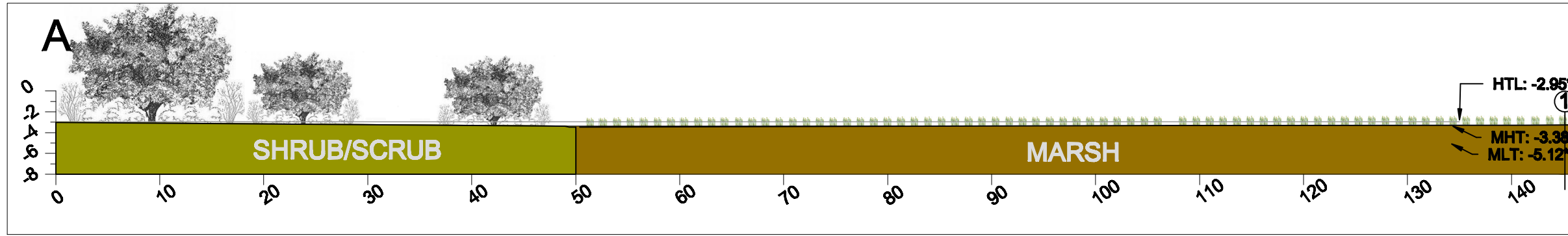

*All elevations are site specific elevations tied to a point located within the project area. These elevations do not correspond to any State Plane System

DEWEY BEACH SUNSET PARK
 101 DAGSWORTHY STREET
 DEWEY BEACH, DELAWARE 19971

DESIGN
 CROSS SECTIONS A THROUGH C
 CURRENT CONDITIONS

DELAWARE CENTER FOR THE INLAND BAYS
 39375 Inlet Road,
 Rehoboth Beach, DE 19971
 (302) 226-6106 www.inlandbays.org

SOVEREIGN CONSULTING INC.
 50 West Welsh Pool Rd., Suite 6
 Exton, Pennsylvania 19341
 (610) 524-6124 www.sovcon.com

Created By: DJS	Original: 11/14/16	Figure:
Revision Date	By	Sheets Affected
11.22.16	DJS	ALL

2.1

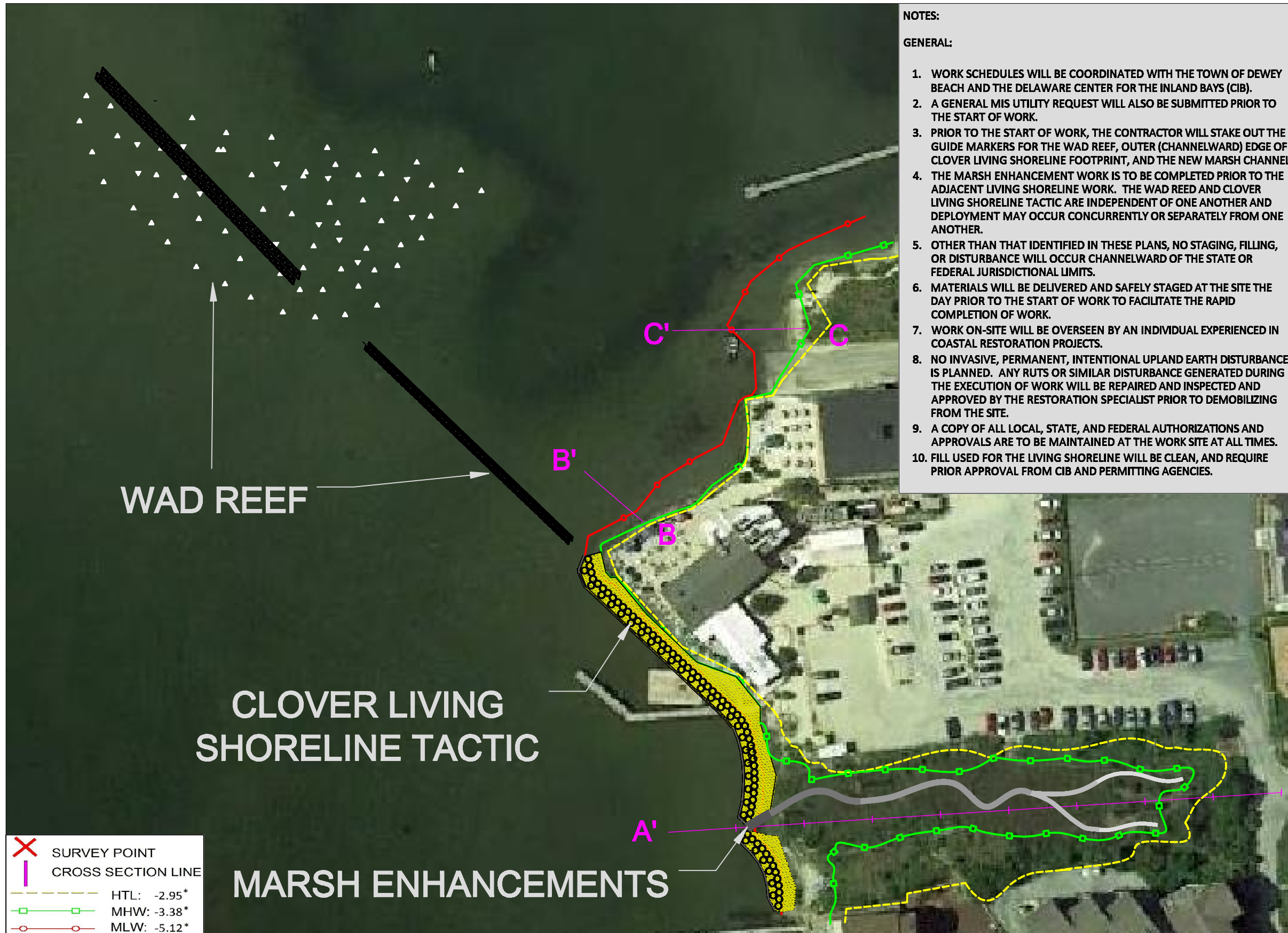

NOTES:

GENERAL:

1. WORK SCHEDULES WILL BE COORDINATED WITH THE TOWN OF DEWEY BEACH AND THE DELAWARE CENTER FOR THE INLAND BAYS (CIB).
2. A GENERAL MIS UTILITY REQUEST WILL ALSO BE SUBMITTED PRIOR TO THE START OF WORK.
3. PRIOR TO THE START OF WORK, THE CONTRACTOR WILL STAKE OUT THE GUIDE MARKERS FOR THE WAD REEF, OUTER (CHANNELWARD) EDGE OF CLOVER LIVING SHORELINE FOOTPRINT, AND THE NEW MARSH CHANNEL.
4. THE MARSH ENHANCEMENT WORK IS TO BE COMPLETED PRIOR TO THE ADJACENT LIVING SHORELINE WORK. THE WAD REEF AND CLOVER LIVING SHORELINE TACTIC ARE INDEPENDENT OF ONE ANOTHER AND DEPLOYMENT MAY OCCUR CONCURRENTLY OR SEPARATELY FROM ONE ANOTHER.
5. OTHER THAN THAT IDENTIFIED IN THESE PLANS, NO STAGING, FILLING, OR DISTURBANCE WILL OCCUR CHANNELWARD OF THE STATE OR FEDERAL JURISDICTIONAL LIMITS.
6. MATERIALS WILL BE DELIVERED AND SAFELY STAGED AT THE SITE THE DAY PRIOR TO THE START OF WORK TO FACILITATE THE RAPID COMPLETION OF WORK.
7. WORK ON-SITE WILL BE OVERSEEN BY AN INDIVIDUAL EXPERIENCED IN COASTAL RESTORATION PROJECTS.
8. NO INVASIVE, PERMANENT, INTENTIONAL UPLAND EARTH DISTURBANCE IS PLANNED. ANY RUTS OR SIMILAR DISTURBANCE GENERATED DURING THE EXECUTION OF WORK WILL BE REPAIRED AND INSPECTED AND APPROVED BY THE RESTORATION SPECIALIST PRIOR TO DEMOBILIZING FROM THE SITE.
9. A COPY OF ALL LOCAL, STATE, AND FEDERAL AUTHORIZATIONS AND APPROVALS ARE TO BE MAINTAINED AT THE WORK SITE AT ALL TIMES.
10. FILL USED FOR THE LIVING SHORELINE WILL BE CLEAN, AND REQUIRE PRIOR APPROVAL FROM CIB AND PERMITTING AGENCIES.



*All elevations are site specific elevations tied to a point located within the project area. These elevations do not correspond to any State Plane System

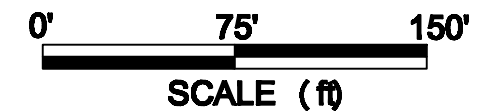

DEWEY BEACH SUNSET PARK
101 DAGSWORTHY STREET
DEWEY BEACH, DELAWARE 19971

DESIGN
WAD REEF, CLOVER LIVING SHORELINE TACTIC AND MARSH ENHANCEMENTS

DELAWARE CENTER FOR THE INLAND BAYS
39375 Inlet Road,
Rehoboth Beach, DE 19971
(302) 228-6106 www.inlandbays.org

SOVEREIGN CONSULTING INC.
50 West Welsh Pool Rd., Suite 6
Exton, Pennsylvania 19341
(610) 524-8124 www.sovcon.com

Created By: DJS	Original: 11/14/16	Figure:
Revision Date	By	Sheets Affected
11.22.16	DJS	ALL

3.0

OPTION 1 LINEAR ARRAY CONFIGURATION

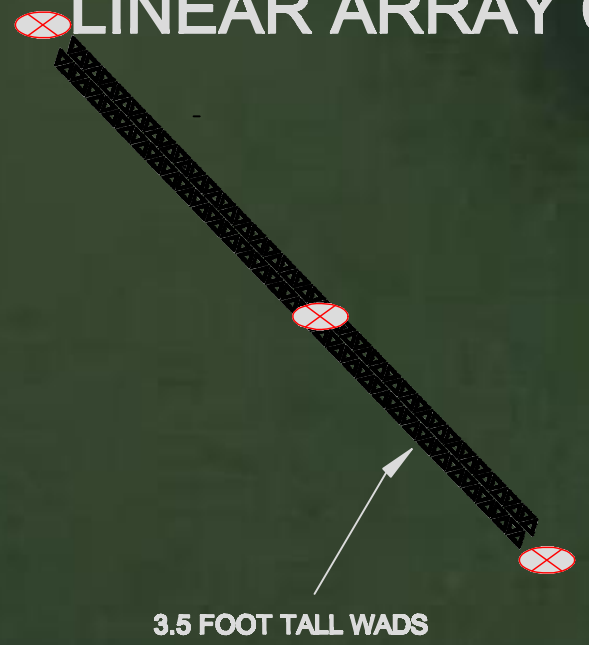

OPTION 2 RANDOM PATCH CONFIGURATION



- PERMANENT MARKER BUOY
- SURVEY POINT
- CROSS SECTION LINE
- HTL: -2.95*
- MHW: -3.38*
- MLW: -5.12*

SEQUENCING WAD REEF:

1. WAD WILL BE POURED AND CURED OFF-SITE AT A NEARBY CEMENT PLANT.
2. AT THE TIME OF DEPLOYMENT, THE WADS MAY BE TEMPORARILY STAGED AT THE TERMINUS OF DAGSWORTHY STREET OR TAKEN TO THE MARINA WHERE A BARGE IS TIED.
3. WADS ARE TO BE LOADED ON BARGES AND DEPLOYED AS DEPICTED ON PLANS. THE EQUIPMENT OPERATOR SHALL BE ASSISTED BY AT LEAST ONE SPOTTER.
4. PRIOR TO DEPLOYMENT, USING 8 FOOT STAKES, STAKE OUT OUTER EDGE OF LINEAR REEF ARRAYS AND, IF APPLICABLE, THE LIMITS OF THE PATCH REEF ARRAYS. ALL STAKES ARE TO BE FLAGGED WITH AT LEAST 144 SQUARE INCH FLAGGING, AND SHALL REMAIN IN PLACE UNTIL DEPLOYMENT IS COMPLETE.
5. FOLLOWING COMPLETION OF DEPLOYMENT, PERMANENT BUOYS ARE TO BE DEPLOYED AS NOTED ON PLANS.

MATERIAL VOLUME ESTIMATES:

UNIT DESCRIPTION: UNITS:	NUMBER OF
WADS OPTION 1	
MARKER BUOY	5
2.0' TALL WADS	196
3.5' TALL WADS	128
WADS OPTION 2	
MARKER BUOY	6
2.0' TALL WADS	196
3.5' TALL WADS	75

THIS PORTION OF THE WAD REEF IS A COMPONENT OF BOTH OPTIONS

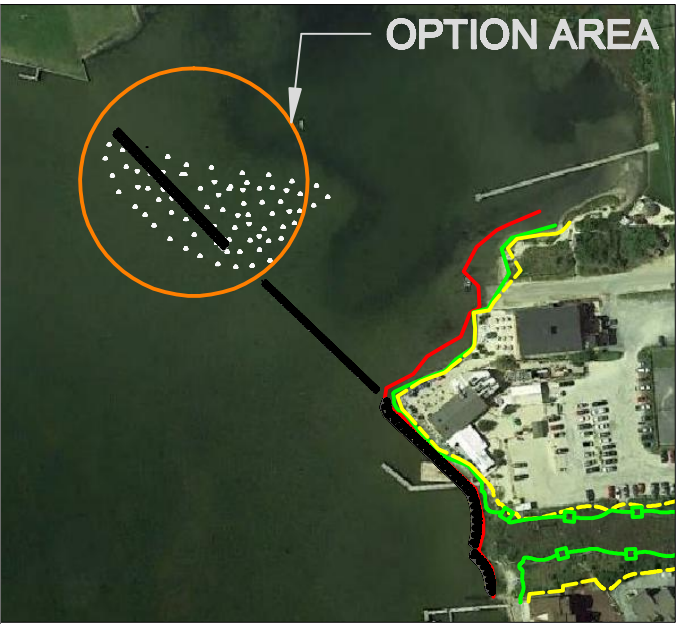

*All elevations are site specific elevations tied to a point located within the project area. These elevations do not correspond to any State Plane System

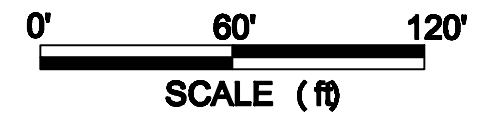

DEWEY BEACH SUNSET PARK
101 DAGSWORTHY STREET
DEWEY BEACH, DELAWARE 19971

**DESIGN
PLAN VIEW
REEF OPTIONS**

DELAWARE CENTER FOR THE INLAND BAYS
39375 Inlet Road,
Rehoboth Beach, DE 19971
(302) 228-6106 www.inlandbays.org

SOVEREIGN CONSULTING INC.
50 West Welsh Pool Rd., Suite 6
Exton, Pennsylvania 19341
(610) 524-6124 www.sovcon.com

Created By: DJS	Original: 11/14/16	Figure:
Revision Date	By	Sheets Affected
11.22.16	DJS	ALL

3.1

2.0' TALL WADS ARRANGEMENT

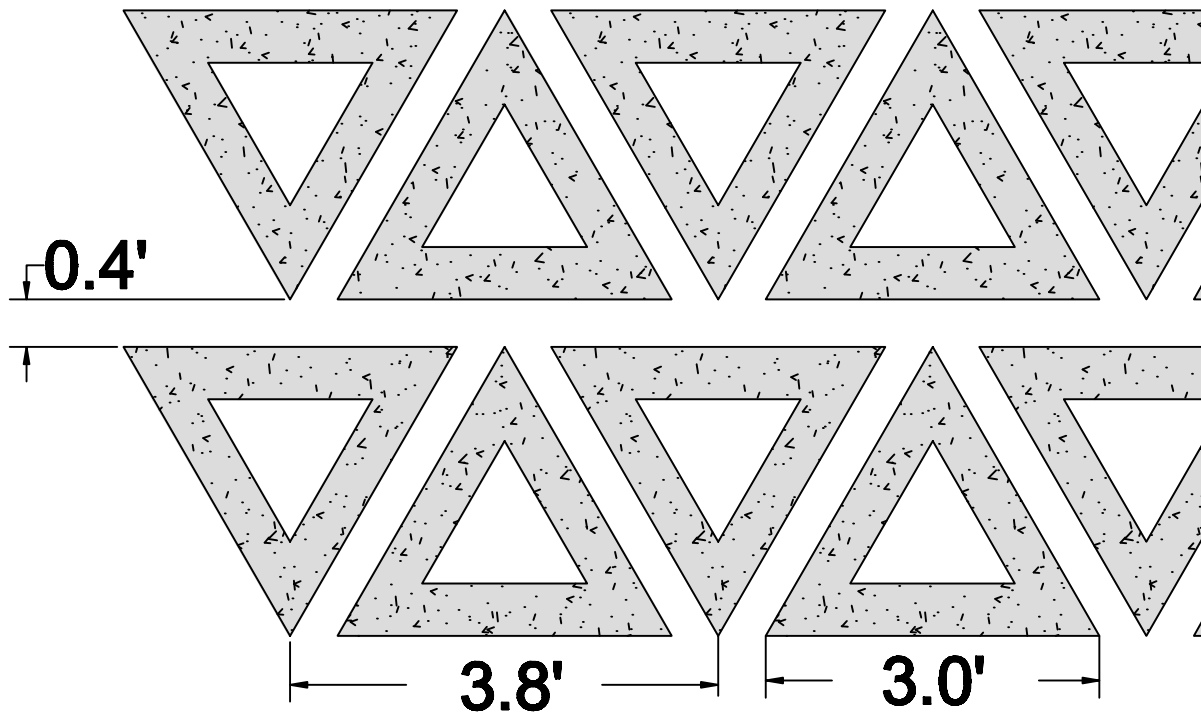

3.5' TALL WADS ARRANGEMENT

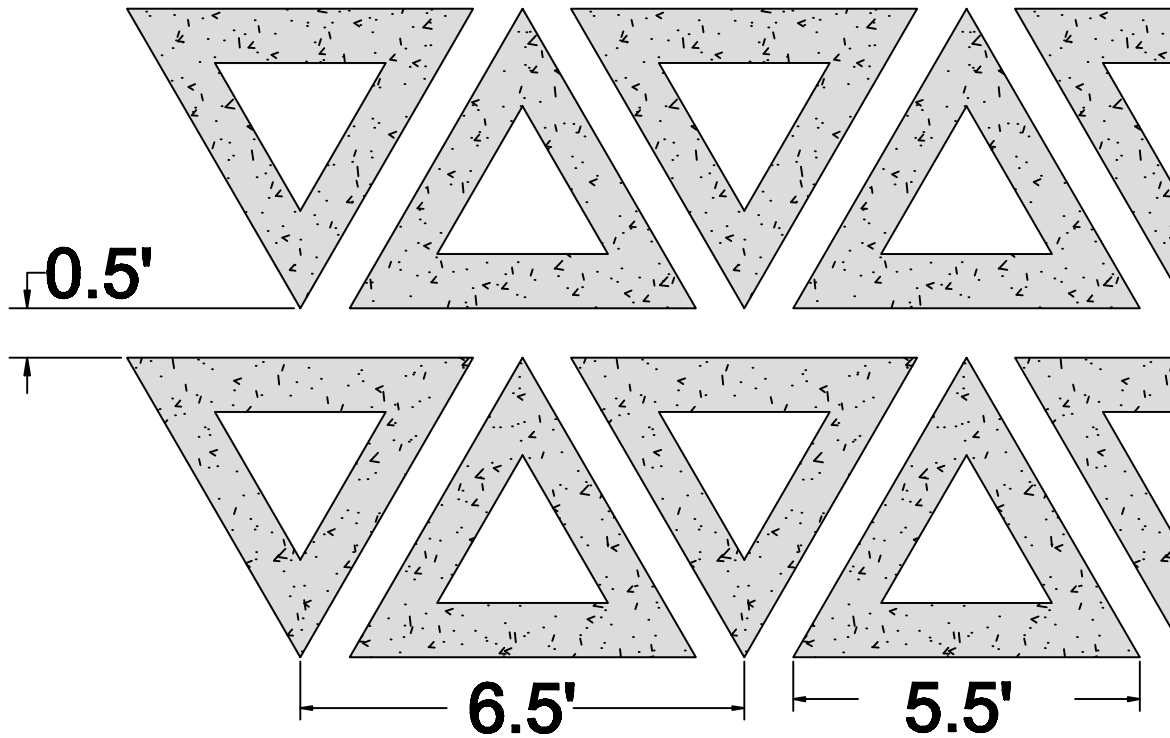

CONCRETE DISC FOR CLOVER TACTIC

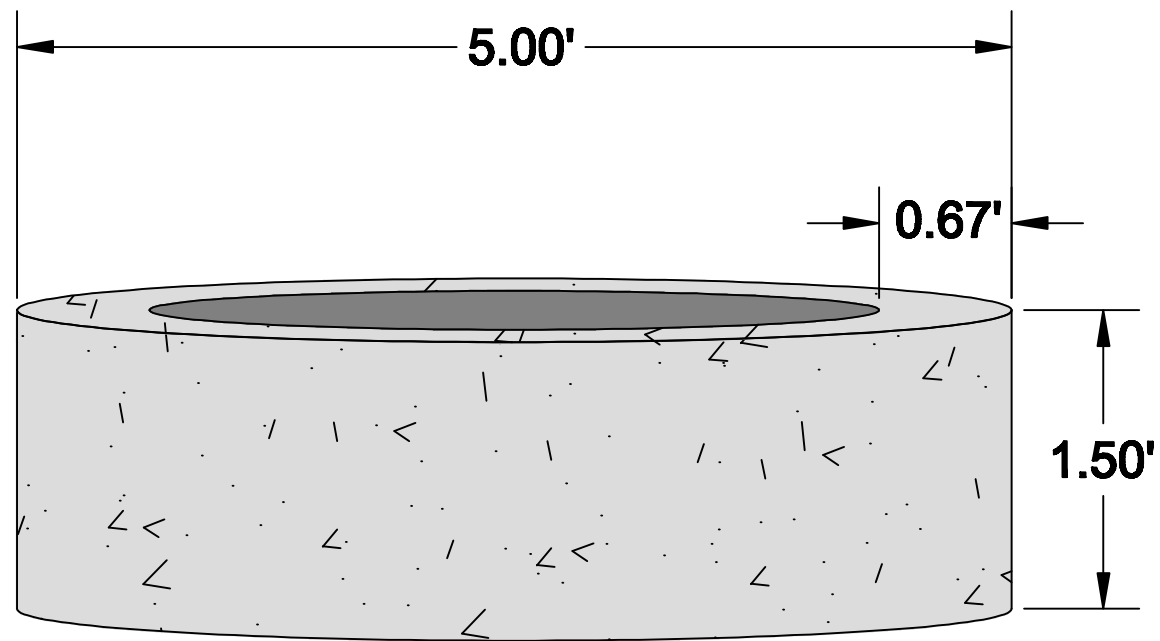

2.0' TALL WADS

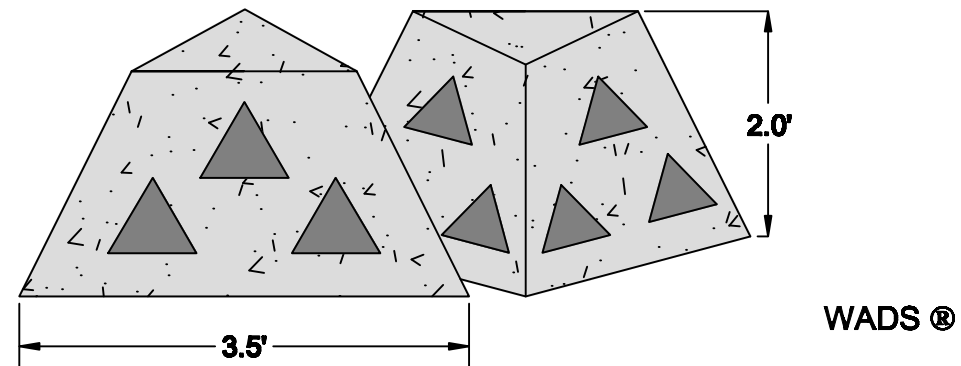

3.5' TALL WADS

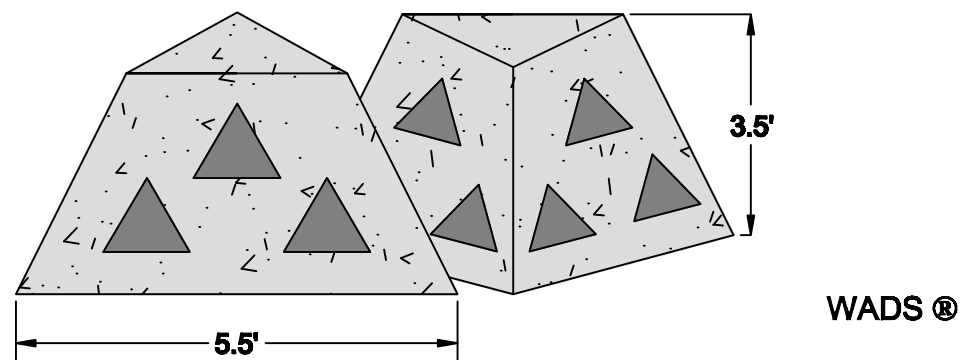

DEWEY BEACH SUNSET PARK
 101 DAGSWORTHY STREET
 DEWEY BEACH, DELAWARE 19971

DESIGN
WAD REEF AND CLOVER TACTIC
DETAIL

DELAWARE CENTER FOR THE INLAND BAYS
 39375 Inlet Road,
 Rehoboth Beach, DE 19971
 (302) 226-6106 www.inlandbays.org

SOVEREIGN CONSULTING INC.
 50 West Welsh Pool Rd., Suite 6
 Exton, Pennsylvania 19341
 (610) 524-8124 www.sovcon.com

Created By: DJS	Original: 11/14/16	Figure:
Revision Date	By	Sheets Affected
11.22.16	DJS	ALL

3.2



SEQUENCING CLOVER LIVING SHORELINE TACTIC:

1. LOCATE POSITION FOR CONCRETE RINGS. WHILE DEPLOYING THE RINGS, IT IS IMPORTANT THAT THE RING TOP IS AT AN ELEVATION APPROXIMATELY 6 INCHES BELOW THE MHT AND LEVEL. THE EQUIPMENT AMY PUSH THE RING INTO THE SEDIMENT TO GAIN PROPER ELEVATION AND LEVELING.
2. DEPLOY AND ANCHOR SHELL BAGS.
3. PLACE SANDY FILL BEHIND (LANDWARD) OF SHELL BAGS. THE SAND SHOULD JUST COVER THE TOP OF THE RINGS
4. PLANT ALL FILLED AREAS.

PLANT SELECTION:

NATIVE PLANT SELECTION		COMMON NAME	FORM	DENSITY	NUMBER
SCIENTIFIC NAME		Saltmarsh Cordgrass	Plug	1 FT OC	5767
SPARTINA ALTERNIFOLIA					

MATERIAL VOLUME ESTIMATES:

Unit Description:	Number of Units:
Concrete Disc	184
Oyster Bags	820
Nylon Rope (1 foot)	630
Hardwood Stakes (2"x2"x3')	90
Sand Backfill (1 CUBIC YARDS)	207



*All elevations are site specific elevations tied to a point located within the project area. These elevations do not correspond to any State Plane System

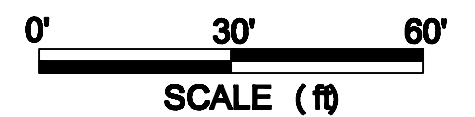

CLOVER LIVING SHORELINE TACTIC

SAND BACKFILL

OYSTER BAGS

	SURVEY POINT
	CROSS SECTION LINE
	HTL: -2.95*
	MHW: -3.38*
	MLW: -5.12*

DEWEY BEACH SUNSET PARK
101 DAGSWORTHY STREET
DEWEY BEACH, DELAWARE 19971

DESIGN PLAN VIEW
CLOVER LIVING SHORELINE TACTIC

DELAWARE CENTER FOR THE INLAND BAYS
39375 Inlet Road,
Rehoboth Beach, DE 19971
(302) 228-6106 www.inlandbays.org

SOVEREIGN CONSULTING INC.
50 West Welsh Pool Rd., Suite 6
Exton, Pennsylvania 19341
(610) 524-6124 www.sovcon.com

Created By: DJS	Original: 11/14/16	Figure: 3.3
Revision Date	By	
11.22.16	DJS	

Sheets Affected: ALL



*All elevations are site specific elevations tied to a point located within the project area. These elevations do not correspond to any State Plane System

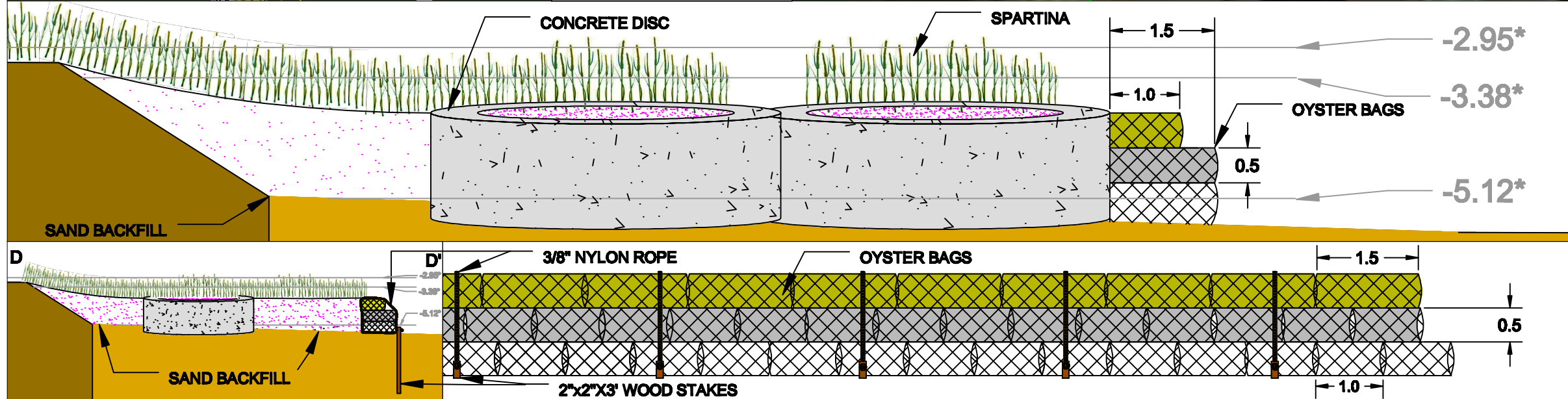

DEWEY BEACH SUNSET PARK 101 DAGSWORTHY STREET DEWEY BEACH, DELAWARE 19971		
DESIGN CLOVER LIVING SHORELINE TACTIC DETAIL		
DELAWARE CENTER FOR THE INLAND BAYS 39375 Inlet Road, Rehoboth Beach, DE 19971 (302) 226-6106 www.inlandbays.org		
SOVEREIGN CONSULTING INC. 50 West Welsh Pool Rd., Suite 6 Exton, Pennsylvania 19341 (610) 524-8124 www.sovcon.com		
Created By: DJS	Original: 11/14/16	Figure:
Revision Date	By	Sheets Affected
11.22.16	DJS	ALL
		3.4

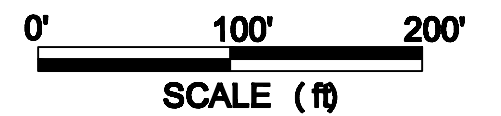
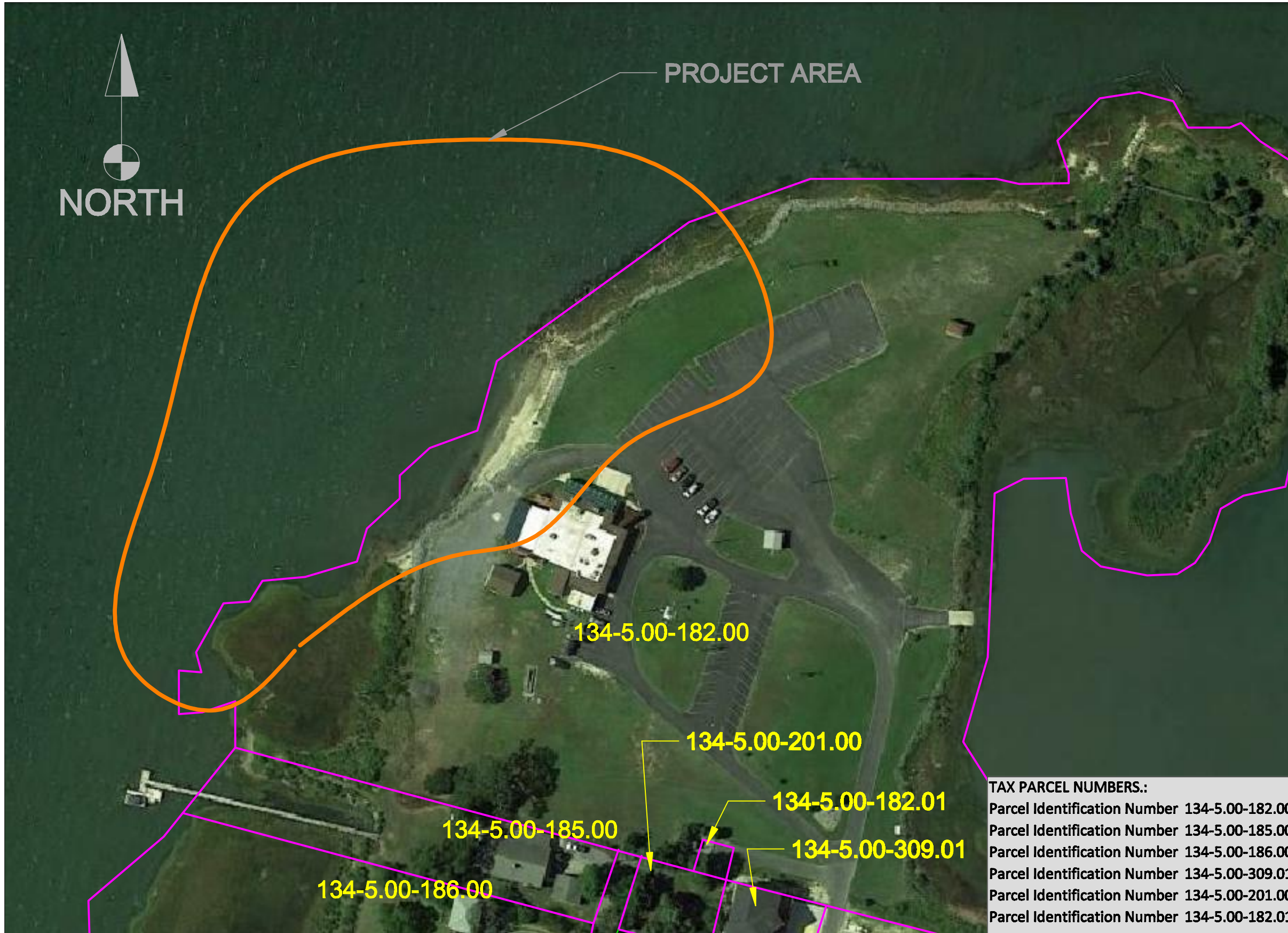

VFW POST - QUILLEN POINT
MARSHY HOPE ROAD,
OCEAN VIEW, DELAWARE 19970

**DESIGN
DETAILS**

DELAWARE CENTER FOR THE INLAND BAYS



39375 Inlet Road,
Rehoboth Beach, DE 19971
Phone: (302) 228-6105
www.inlandbays.org

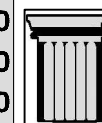

SOVEREIGN CONSULTING INC.
50 West Welsh Pool Rd., Suite 6
Exton, Pennsylvania 19341
Phone: (610) 824-8124 Fax: (610) 824-8129
www.sovcon.com

TAX PARCEL NUMBERS.:

Parcel Identification Number 134-5.00-182.00
Parcel Identification Number 134-5.00-185.00
Parcel Identification Number 134-5.00-186.00
Parcel Identification Number 134-5.00-309.01
Parcel Identification Number 134-5.00-201.00
Parcel Identification Number 134-5.00-182.01

Created By: DJS	Original: 9/30/16	Figure:
Revision Date	By	Sheets Affected
11.22.16	DJS	ALL
		1.0

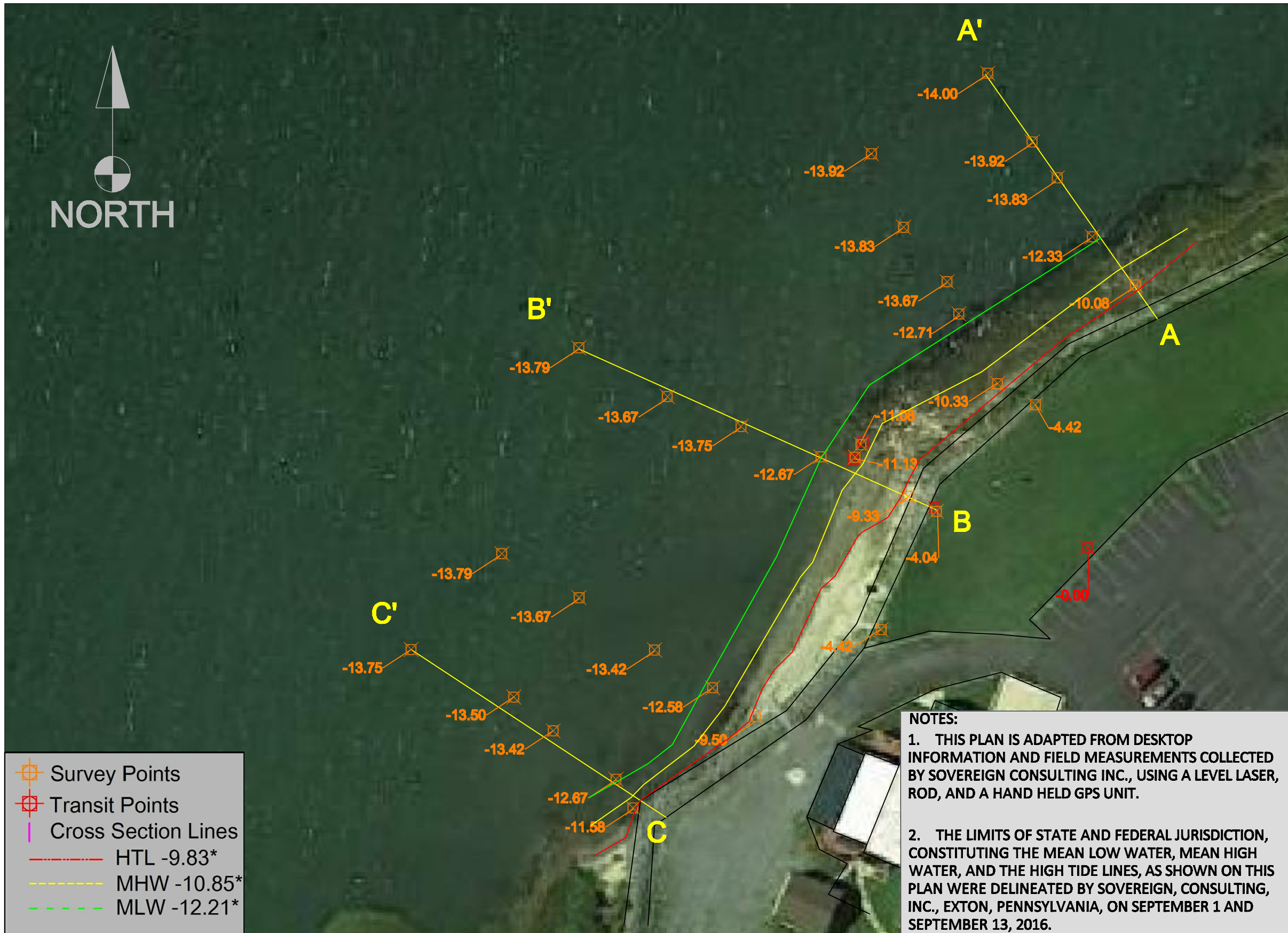

*All elevations are site specific elevations tied to a point located within the project area. These elevations do not correspond to any State Plane System

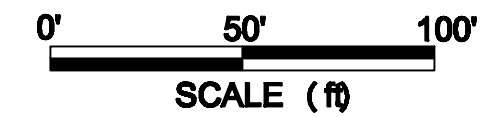

**VFW POST - QUILLEN POINT
MARSHY HOPE ROAD,
OCEAN VIEW, DELAWARE 19970**

**TOPO MAP WITH CROSS SECTION KEY
EXISTING CONDITIONS**

DELAWARE CENTER FOR THE INLAND BAYS
39375 Inlet Road,
Rehoboth Beach, DE 19971
Phone: (302) 228-6105
www.inlandbays.org

SOVEREIGN CONSULTING INC.
50 West Welsh Pool Rd., Suite 6
Exton, Pennsylvania 19341
Phone: (610) 624-6124 Fax: (610) 624-6129
www.sovcon.com

Created By: DJS	Original: 9/30/16	Figure: 2.0
Revision Date	By	
11.22.16	DJS	
Sheets Affected		
ALL		

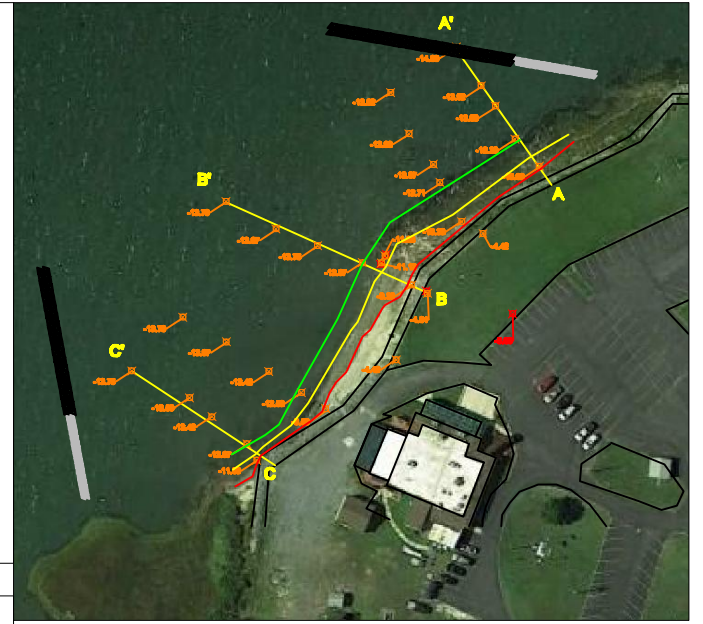
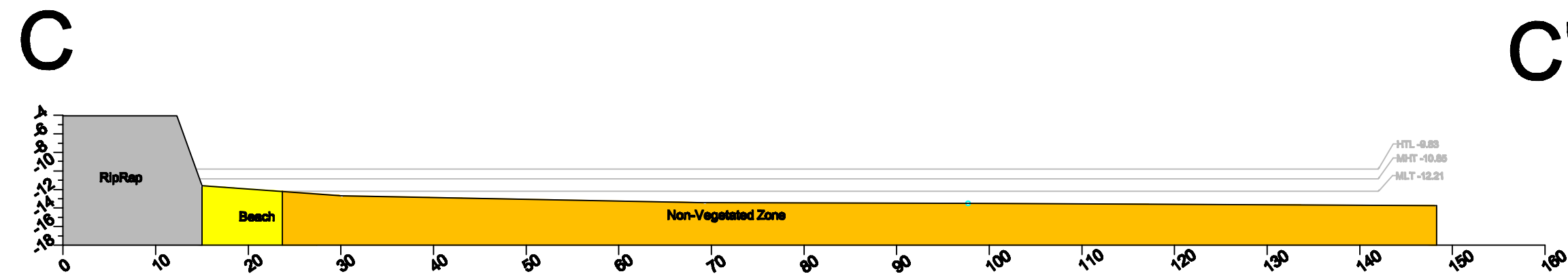
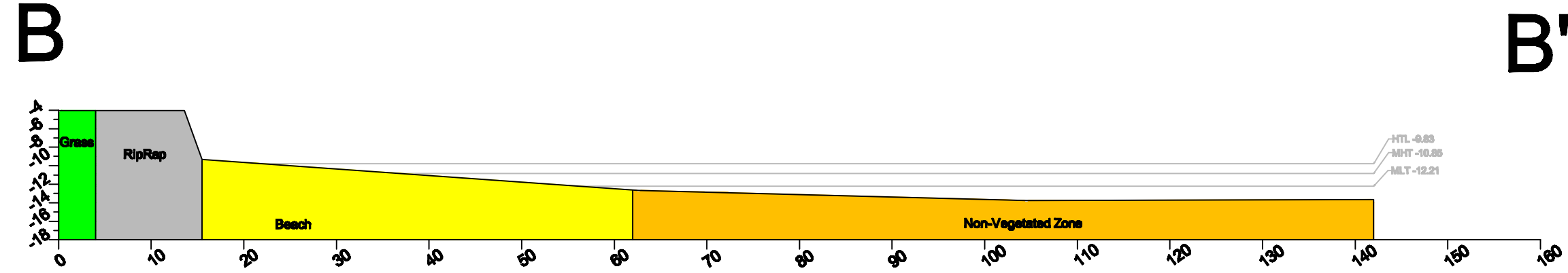
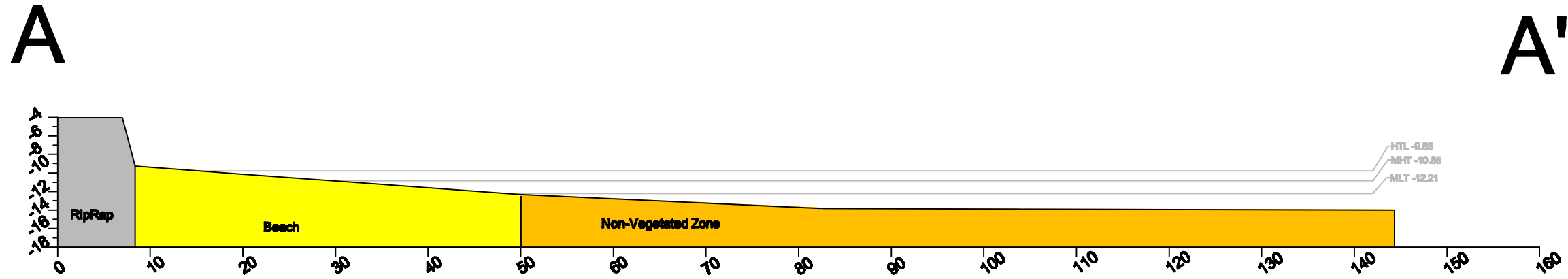

*All elevations are site specific elevations tied to a point located within the project area. These elevations do not correspond to any State Plane System

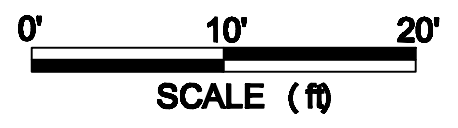

**VFW POST - QUILLEN POINT
MARSHY HOPE ROAD,
OCEAN VIEW, DELAWARE 19970**

**CROSS SECTIONS A THROUGH C
EXISTING CONDITIONS**

DELAWARE CENTER FOR THE INLAND BAYS
39375 Inlet Road,
Rehoboth Beach, DE 19971
Phone: (302) 226-6106
www.inlandbays.org

SOVEREIGN CONSULTING INC.
50 West Welsh Pool Rd., Suite 6
Exton, Pennsylvania 19341
Phone: (610) 624-6124 Fax: (610) 624-6129
www.sovcon.com

Created By: DJS	Original: 9/30/16	Figure: 2.1
Revision Date	By	
11.22.16	DJS	
	Sheets Affected	ALL









DEPLOYMENT EAST 1
100 - 3.5' TALL WADS

DEPLOYMENT EAST 2
67 - 2.0' TALL WADS

DEPLOYMENT WEST 1
80 - 3.5' TALL WADS

DEPLOYMENT WEST 2
68 - 2.0' TALL WADS

-  Survey Points
-  Transit Points
-  Cross Section Lines
-  HTL -9.83*
-  MHW -10.85*
-  MLW -12.21*

MATERIAL VOLUME ESTIMATES:

UNIT DESCRIPTION:

WADS OPTION 1

MARKER BUOY
2.0' TALL WADS
3.5' TALL WADS

NUMBER OF UNITS:

4
128
180

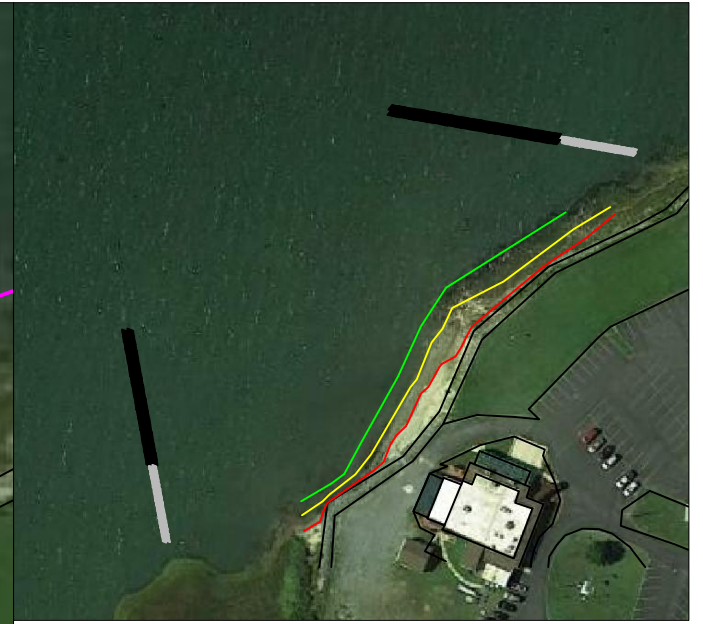

*All elevations are site specific elevations tied to a point located within the project area. These elevations do not correspond to any State Plane System

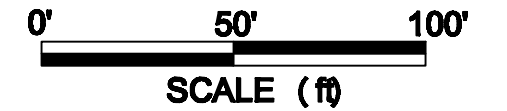

VFW POST - QUILLEN POINT
MARSHY HOPE ROAD,
OCEAN VIEW, DELAWARE 19970

ENERGY ATTENUATION REEF

DELAWARE CENTER FOR THE INLAND BAYS



39375 Inlet Road,
Rehoboth Beach, DE 19971
Phone: (302) 228-6105
www.inlandbays.org

SOVEREIGN CONSULTING INC.

50 West Welsh Pool Rd., Suite 6
Exton, Pennsylvania 19341
Phone: (610) 824-8124 Fax: (610) 824-8129
www.sovcon.com

Created By: DJS	Original: 9/30/16	Figure: 3.0	
Revision Date	By		Sheets Affected
11.22.16	DJS		ALL

2.0' TALL WADS

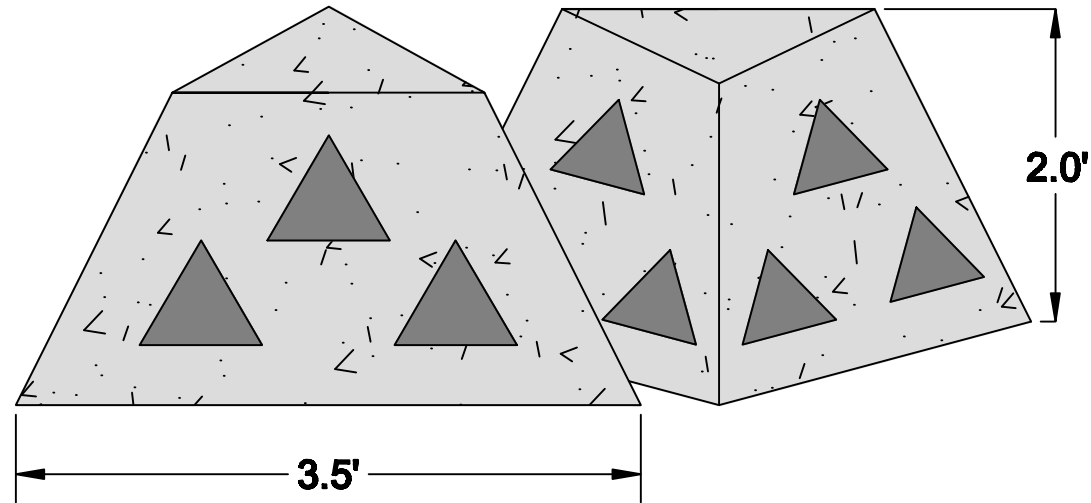

WADS ®

2.0' TALL WADS ARRANGEMENT

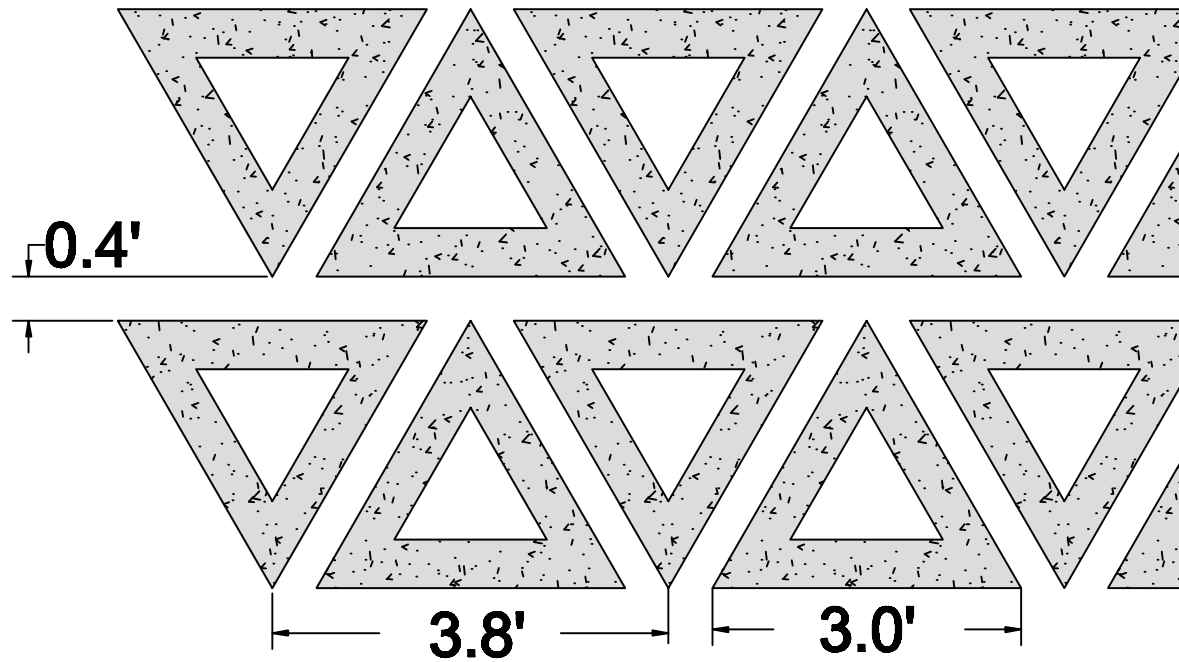

3.5' TALL WADS

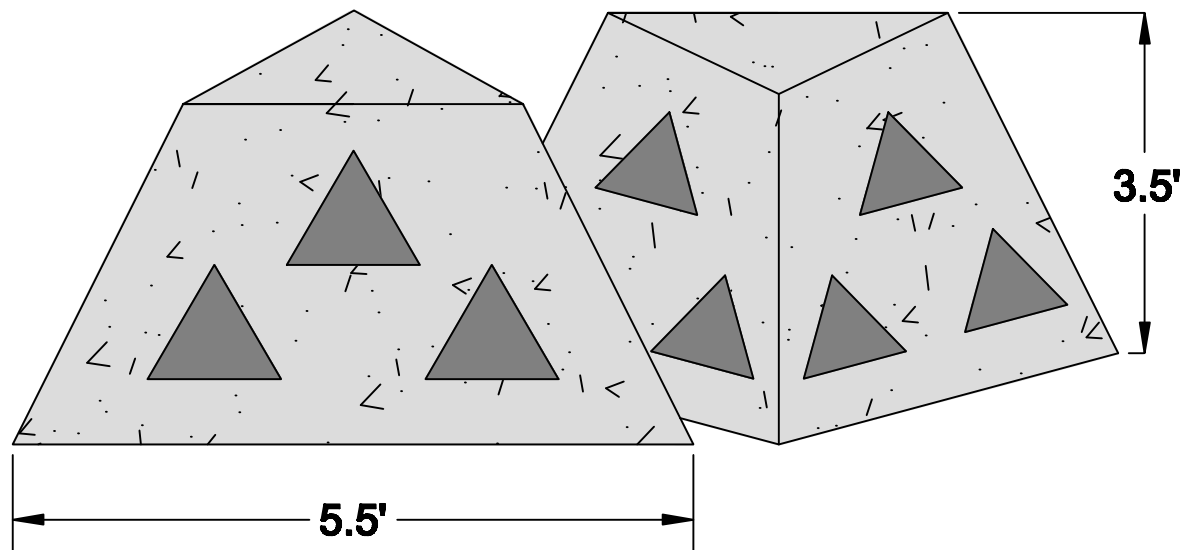

WADS ®

3.5' TALL WADS ARRANGEMENT

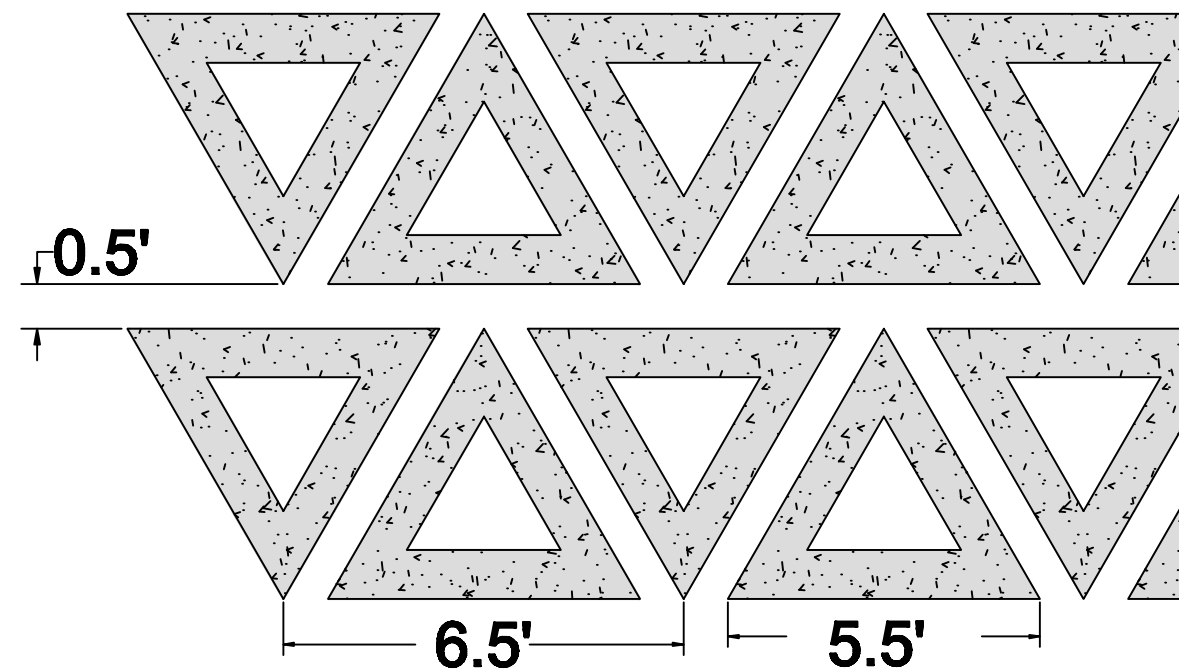

**VFW POST - QUILLEN POINT
MARSHY HOPE ROAD,
OCEAN VIEW, DELAWARE 19970**

**ENERGY ATTENUATION REEF
DETAIL**

DELAWARE CENTER FOR THE INLAND BAYS



39375 Inlet Road,
Rehoboth Beach, DE 19971
Phone: (302) -226-6106
www.inlandbays.org

SOVEREIGN CONSULTING INC.

50 West Welsh Pool Rd., Suite 6
Exton, Pennsylvania 19341
Phone: (610) 524-8124 Fax: (610) 524-8129
www.sovcon.com

Created By: DJS	Original: 9/30/16	Figure:
Revision Date	By	Sheets Affected
11.22.16	DJS	ALL

3.1

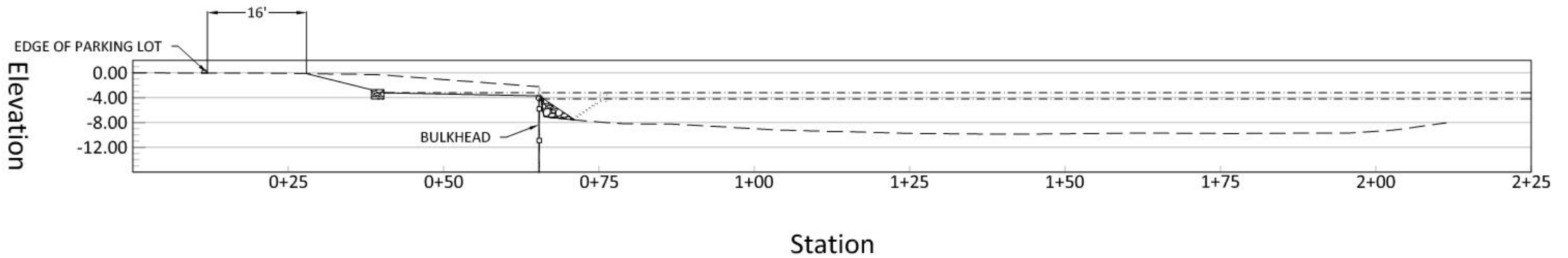

Profile View

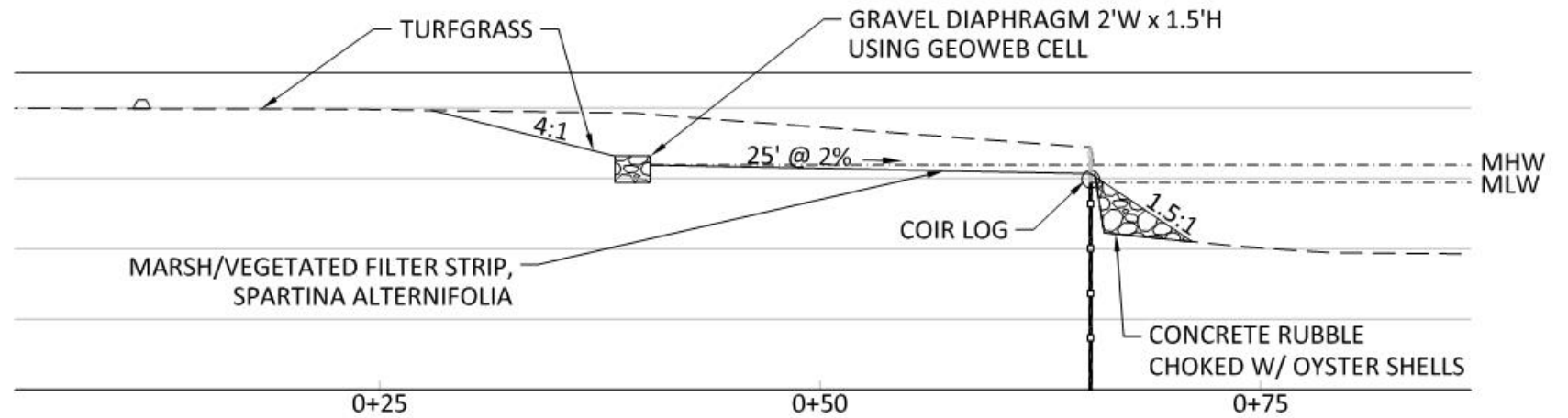

Rummel, Klepper & Kahl, LLP

110 S. POPLAR STREET | WILMINGTON, DE 19801

SUITE 102

PH: (302) 468-4880

Engineers | Construction Managers | Planners | Scientists

www.rkk.com

ALTERNATIVE 1

PREPARED BY EMG

CHECKED BY LGT

SEPTEMBER 2016

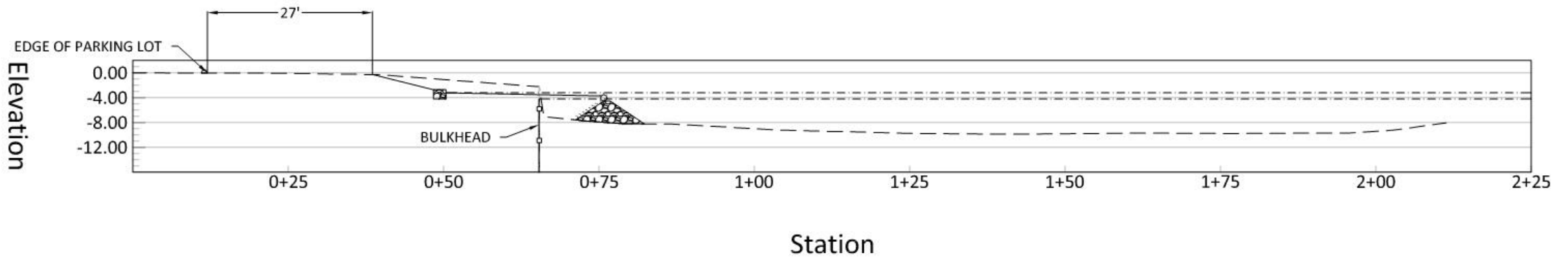

Profile View

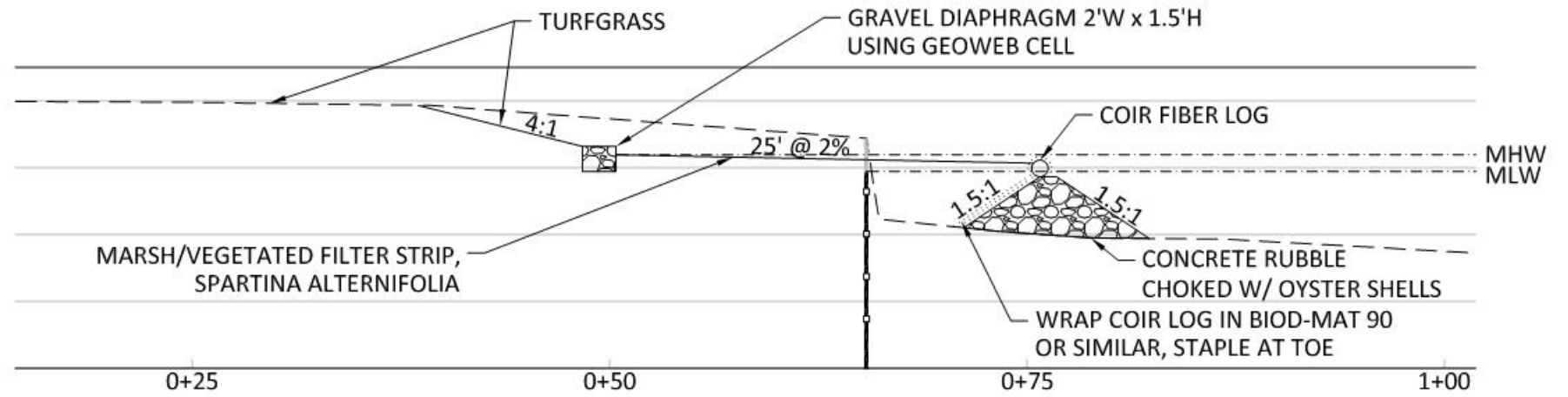

Rummel, Klepper & Kahl, LLP

110 S. POPLAR STREET | WILMINGTON, DE 19801

SUITE 102

PH: (302) 468-4880

Engineers | Construction Managers | Planners | Scientists

www.rkk.com

ALTERNATIVE 2

PREPARED BY EMG

CHECKED BY LGT

SEPTEMBER 2016

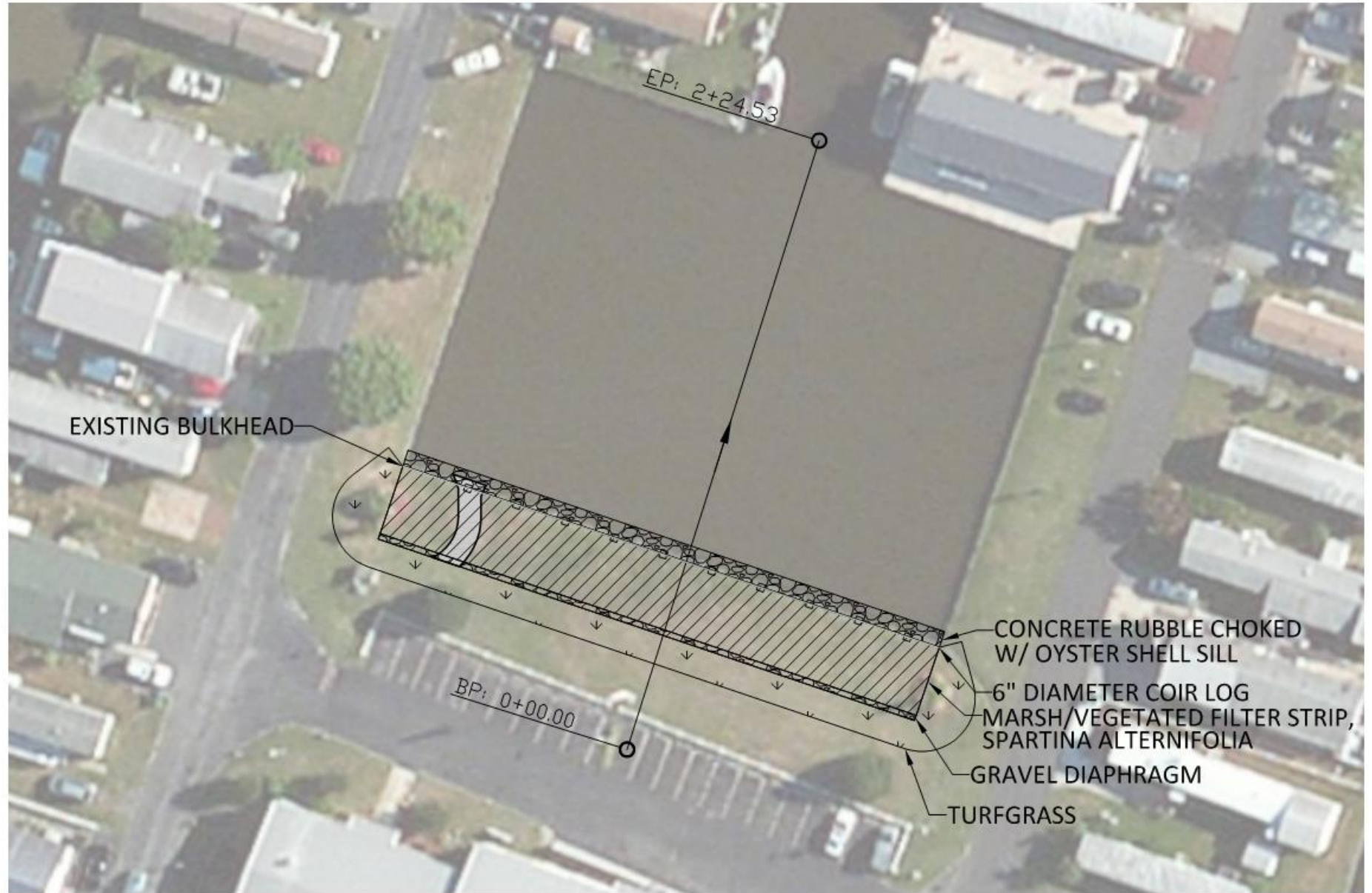

ALTERNATIVE 1

PREPARED BY EMG
 CHECKED BY LGT
 SEPTEMBER 2016



Rummel, Klepper & Kahl, LLP

110 S. POPLAR STREET | WILMINGTON, DE 19801

SUITE 102

PH: (302) 468-4880

Engineers | Construction Managers | Planners | Scientists

www.rkk.com



Rummel, Klepper & Kahl, LLP

110 S. POPLAR STREET | WILMINGTON, DE 19801

SUITE 102

PH: (302) 468-4880

Engineers | Construction Managers | Planners | Scientists

www.rkk.com

ALTERNATIVE 2

PREPARED BY EMG

CHECKED BY LGT

SEPTEMBER 2016



ALTERNATIVE 3

PREPARED BY EMG
 CHECKED BY LGT
 OCTOBER 2016



Rummel, Klepper & Kahl, LLP

110 S. POPLAR STREET | WILMINGTON, DE 19801

SUITE 102

PH: (302) 468-4880

Engineers | Construction Managers | Planners | Scientists

www.rkk.com

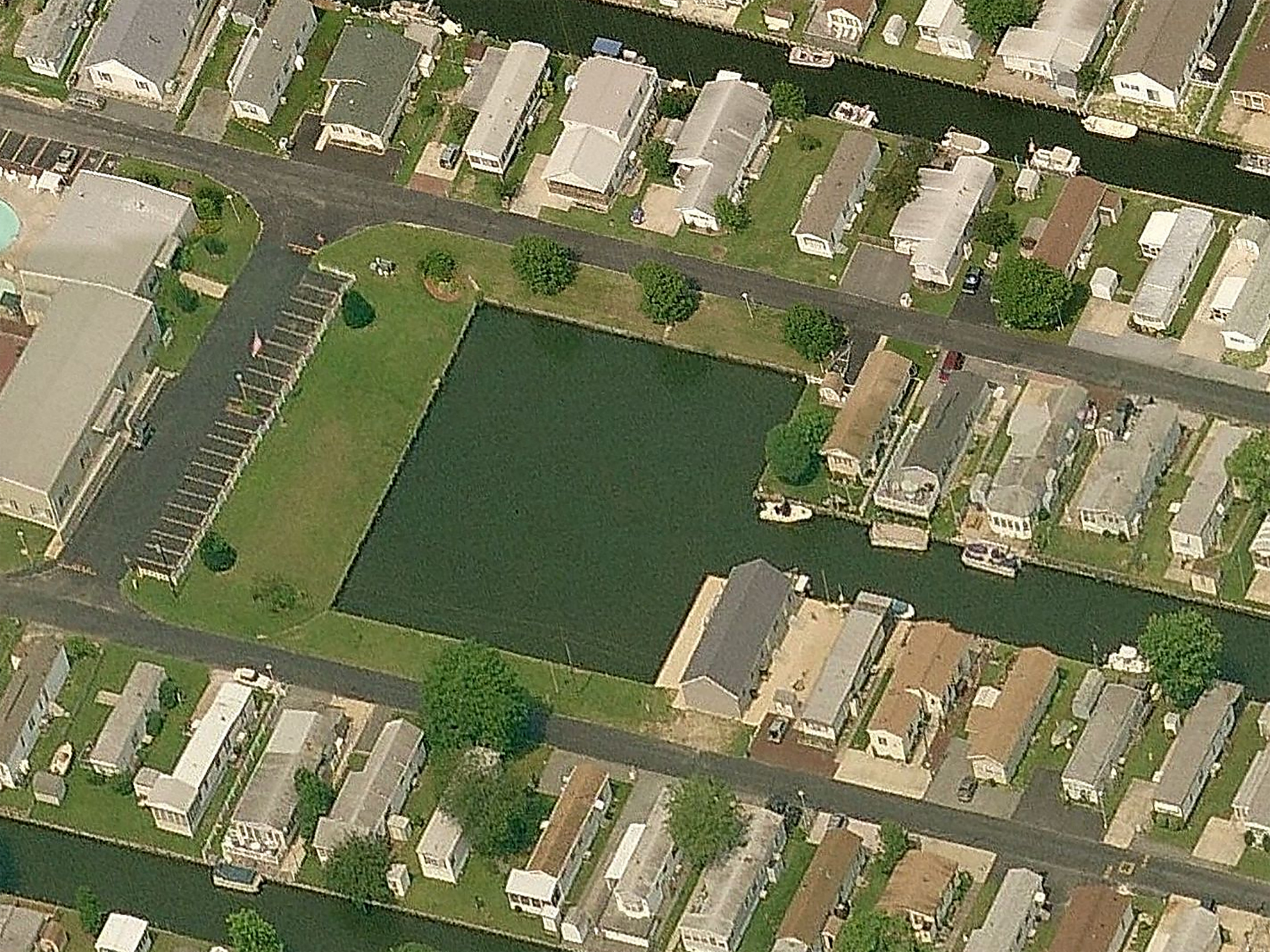







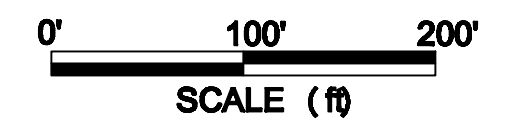
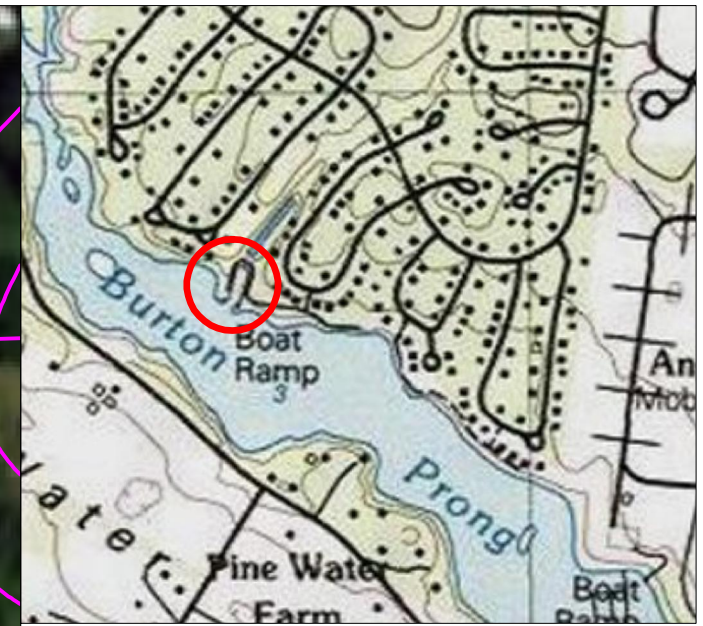

ANGOLA BY THE BAY
 23413 BOAT DOCK DRIVE EAST
 LEWES, DELAWARE 19958

DESIGN
SITE LOCATION MAP

DELAWARE CENTER FOR THE INLAND BAYS

 39375 Inlet Road,
 Rehoboth Beach, DE 19971
 Phone: (302) 226-8105
www.inlandbays.org

SOVEREIGN CONSULTING INC.
 50 West Welsh Pool Rd., Suite 6
 Exton, Pennsylvania 19341
 Phone: (610) 824-8124 Fax: (610) 824-8129
www.sovcon.com

TAX PARCEL NUMBERS.:
 Parcel Identification Number 234-17.08-91.00
 Parcel Identification Number 234-17.08-69.00
 Parcel Identification Number 234-17.00-31.00
 Parcel Identification Number 234-17.00-32.01
 Parcel Identification Number 234-17.00-32.02
 Parcel Identification Number 234-17.00-31.03

Created By: DJS	Original: 9/30/16	Figure: 1.0
Revision Date: 11.22.16	By: DJS	
	Sheets Affected: ALL	

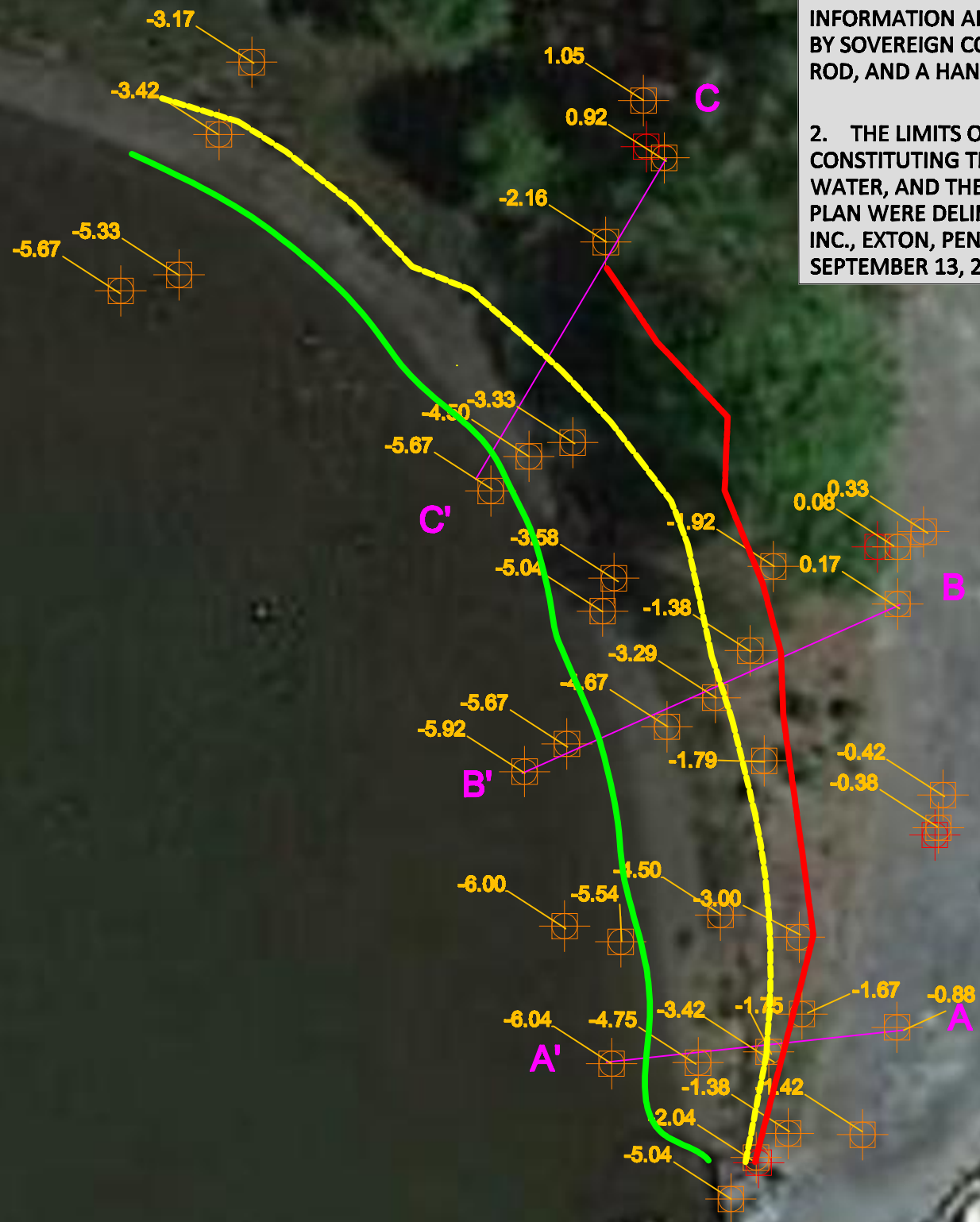

NOTES:

1. THIS PLAN IS ADAPTED FROM DESKTOP INFORMATION AND FIELD MEASUREMENTS COLLECTED BY SOVEREIGN CONSULTING INC., USING A LEVEL LASER, ROD, AND A HAND HELD GPS UNIT.
2. THE LIMITS OF STATE AND FEDERAL JURISDICTION, CONSTITUTING THE MEAN LOW WATER, MEAN HIGH WATER, AND THE HIGH TIDE LINES, AS SHOWN ON THIS PLAN WERE DELINEATED BY SOVEREIGN, CONSULTING, INC., EXTON, PENNSYLVANIA, ON SEPTEMBER 1 AND SEPTEMBER 13, 2016.

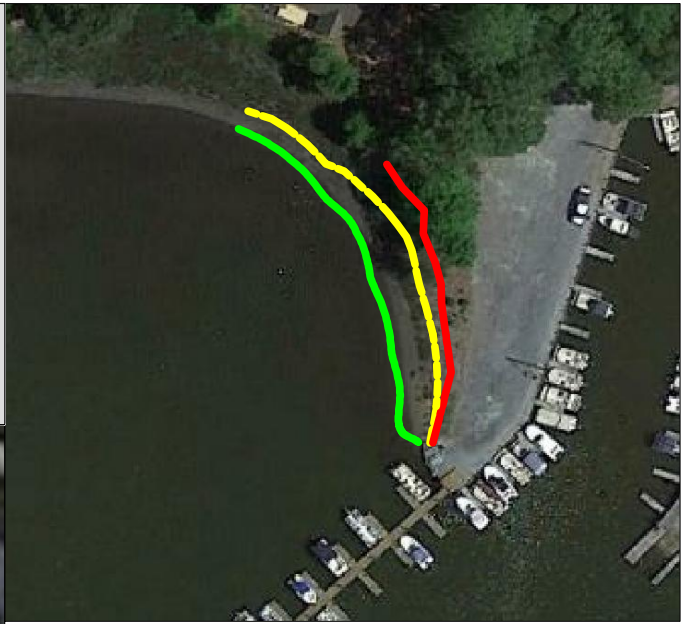

* All elevations are site specific elevations tied to a point located within the project area. These elevations do not correspond to any State Plane System

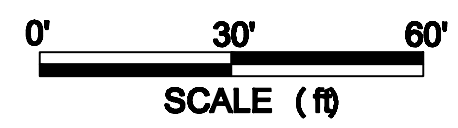

- Survey Points
- Transit Points
- Cross Section Lines
- HTL -2.35*
- MHW -2.76*
- MLW -5.05*

ANGOLA BY THE BAY
23413 BOAT DOCK DRIVE EAST
LEWES, DELAWARE 19958

DESIGN
TOPO MAP WITH CROSS SECTION KEY
EXISTING CONDITIONS

DELAWARE CENTER FOR THE INLAND BAYS
 39375 Inlet Road,
Rehoboth Beach, DE 19971
Phone: (302) 228-8105
www.inlandbays.org

SOVEREIGN CONSULTING INC.
50 West Welsh Pool Rd., Suite 6
Exton, Pennsylvania 19341
Phone: (610) 824-8124 Fax: (610) 824-8129
www.sovcon.com

Created By: DJS	Original: 9/30/16	Figure:
Revision Date	By	Sheets Affected
11.22.16	DJS	ALL

2.0

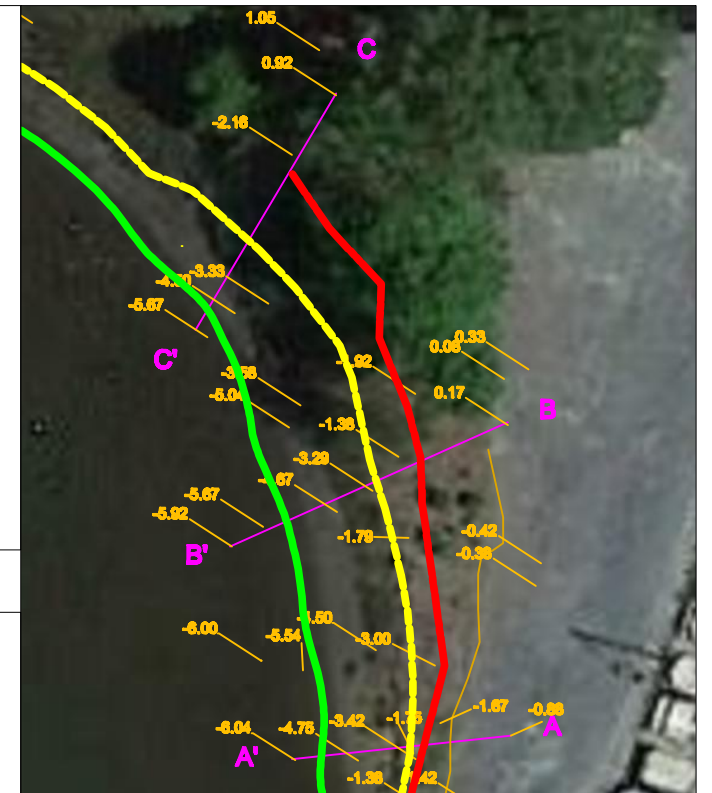
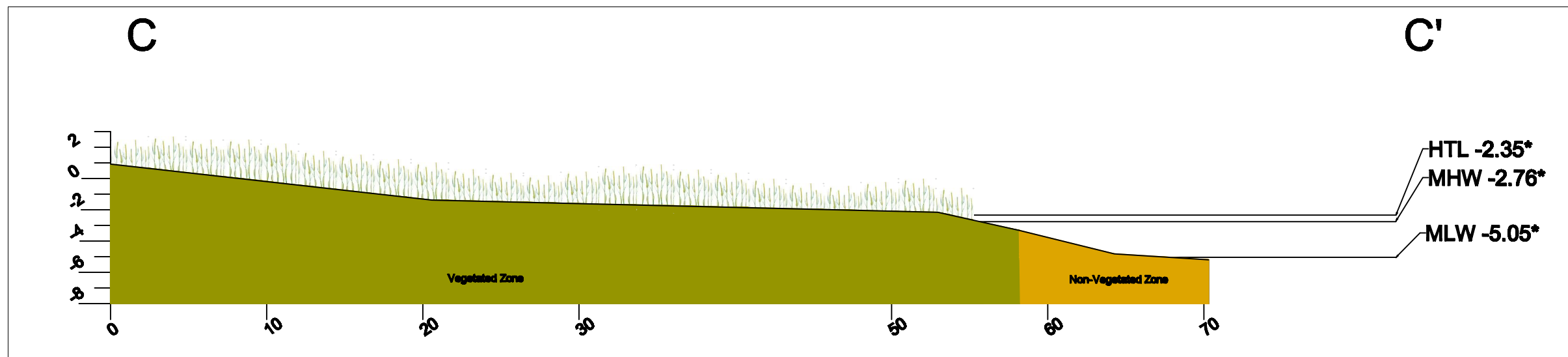
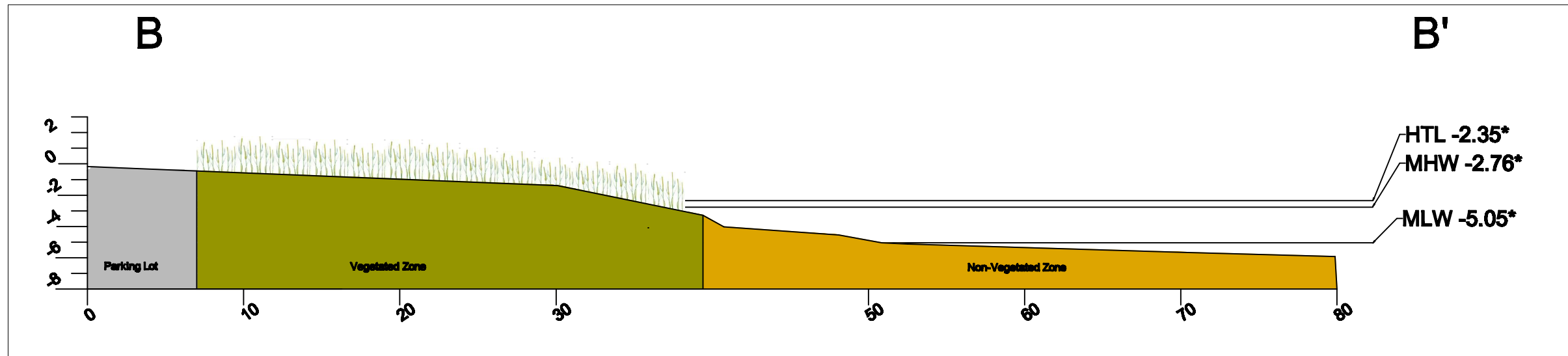

* All elevations are site specific elevations tied to a point located within the project area. These elevations do not correspond to any State Plane System

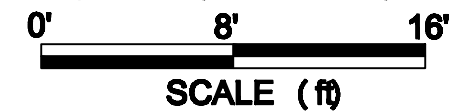

ANGOLA BY THE BAY
23413 BOAT DOCK DRIVE EAST
LEWES, DELAWARE 19958

CROSS SECTIONS A THROUGH C
EXISTING CONDITIONS

DELAWARE CENTER FOR THE INLAND BAYS
39375 Inlet Road,
Rehoboth Beach, DE 19971
Phone: (302) 228-8105
www.inlandbays.org

SOVEREIGN CONSULTING INC.
50 West Welsh Pool Rd., Suite 6
Exton, Pennsylvania 19341
Phone: (610) 824-8124 Fax: (610) 824-8129
www.sovcon.com

Created By: DJS	Original: 9/30/16	Figure: 2.1
Revision Date: 11.22.16	By: DJS	
	Sheets Affected: ALL	



88 FOOT LENGTH

MATERIAL VOLUME ESTIMATES:	
UNIT DESCRIPTION	NUMBER OF UNITS
HEAVY DUTY STAPLES	46
DUCKBILL ANCHOR	54
HARDWOOD LOG 12-15" DIAM (10' LENGTH) TOE UNIT	9
COIR LOG 12" DIAM (10' LENGTHS) PRIMARY UNIT	12
COIR LOG 12" DIAM (3.3' LENGTHS) GAP UNIT	11
4'X2"X2" HARDWOOD STAKES	211
3/8" HEMP ROPE (PER FOOT)	245.5
1/4" STEEL CABLE (PER FOOT)	243



* All elevations are site specific elevations tied to a point located within the project area. These elevations do not correspond to any State Plane System

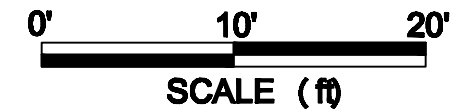

- Hardwood Logs
- Coir Log Units
- HTL -2.35*
- MHW -2.76*
- MLW -5.05*

ANGOLA BY THE BAY
23413 BOAT DOCK DRIVE EAST
LEWES, DELAWARE 19958

DESIGN
CONVENTIONAL LIVING SHORELINE W/
HARDWOOD TOE AND TREATMENTS
PLAN VIEW

DELAWARE CENTER FOR THE INLAND BAYS



39375 Inlet Road,
 Rehoboth Beach, DE 19971
 Phone: (302) -228-8105
www.inlandbays.org



SOVEREIGN CONSULTING INC.
 50 West Welsh Pool Rd., Suite 6
 Exton, Pennsylvania 19341
 Phone: (610) 824-8124 Fax: (610) 824-8129
www.sovcon.com

Created By: DJS	Original: 9/30/16	Figure: 3.0
Revision Date	By	
11.22.16	DJS	ALL

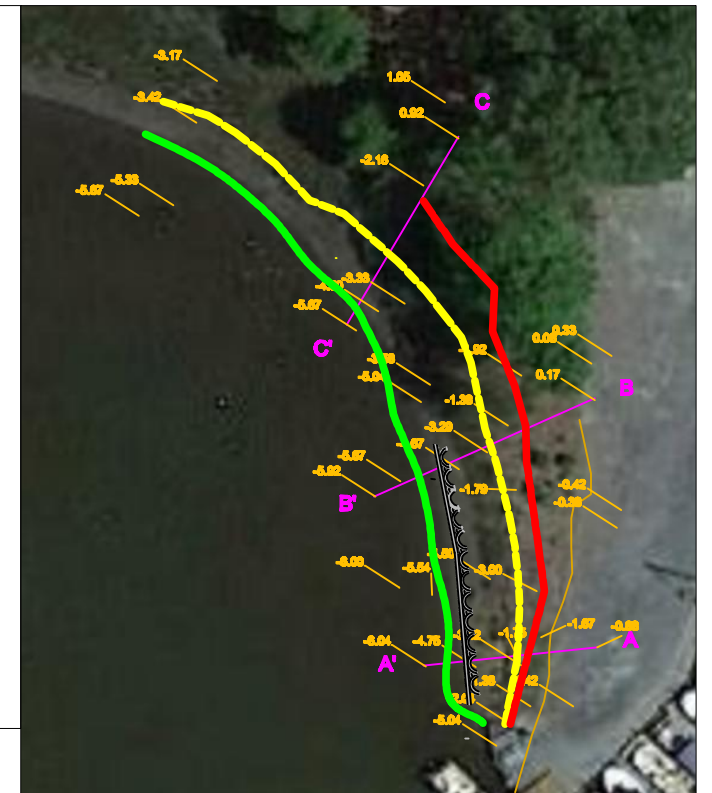
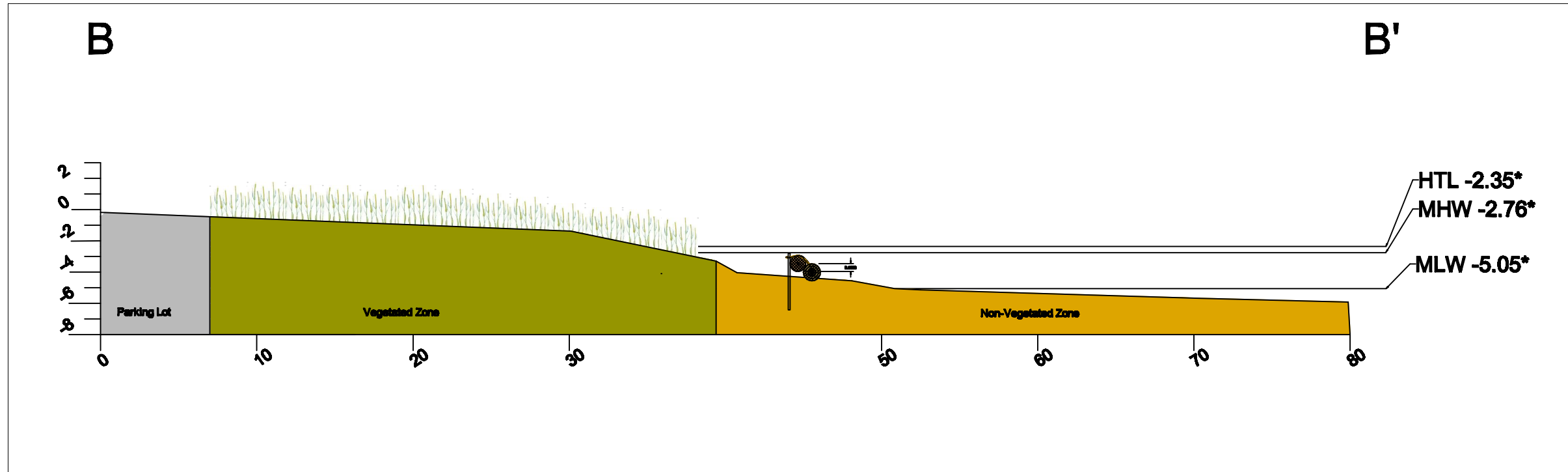

* All elevations are site specific elevations tied to a point located within the project area. These elevations do not correspond to any State Plane System

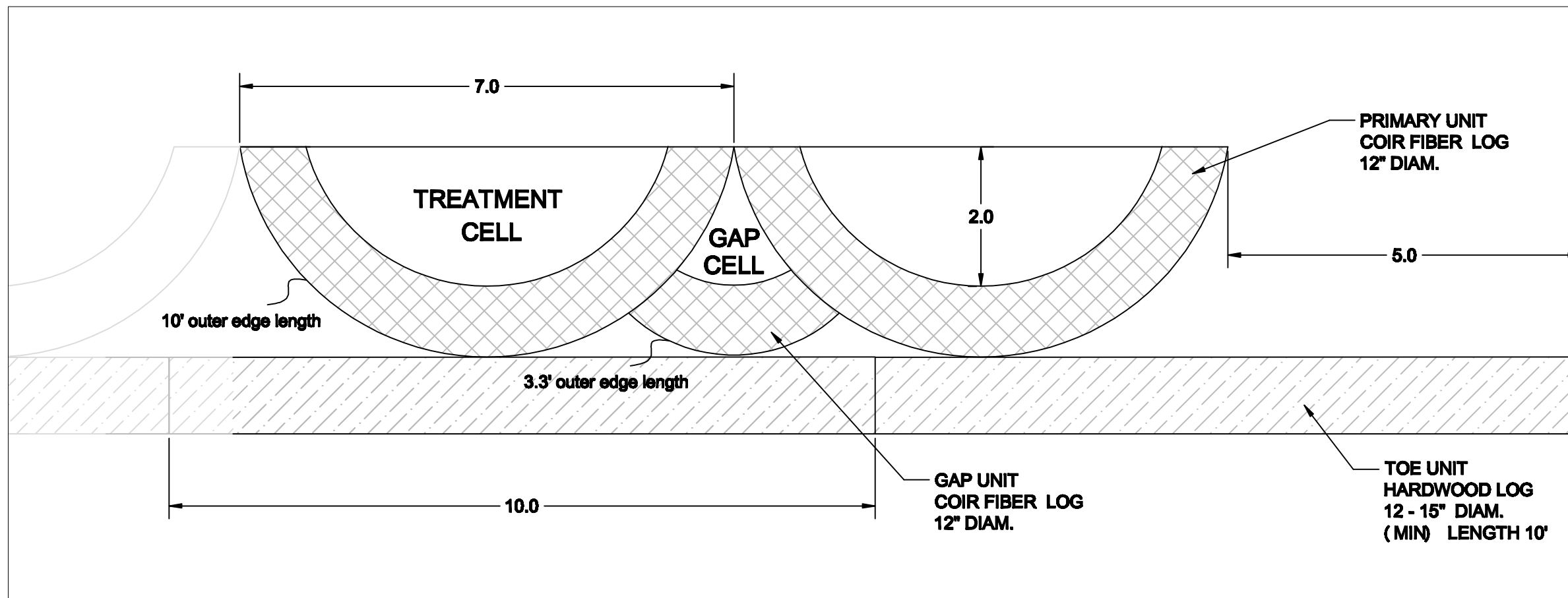
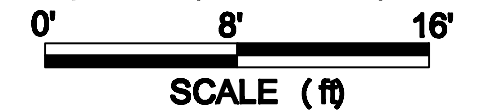

ANGOLA BY THE BAY
23413 BOAT DOCK DRIVE EAST
LEWES, DELAWARE 19958

**DESIGN
CROSS SECTION B
DETAILS**

DELAWARE CENTER FOR THE INLAND BAYS
39375 Inlet Road,
Rehoboth Beach, DE 19971
Phone: (302) 228-8105
www.inlandbays.org

SOVEREIGN CONSULTING INC.
50 West Welsh Pool Rd., Suite 6
Exton, Pennsylvania 19341
Phone: (610) 824-8124 Fax: (610) 824-8129
www.sovcon.com

Created By: DJS	Original: 9/30/16	Figure:
Revision Date	By	Sheets Affected
11.22.16	DJS	ALL

3.1

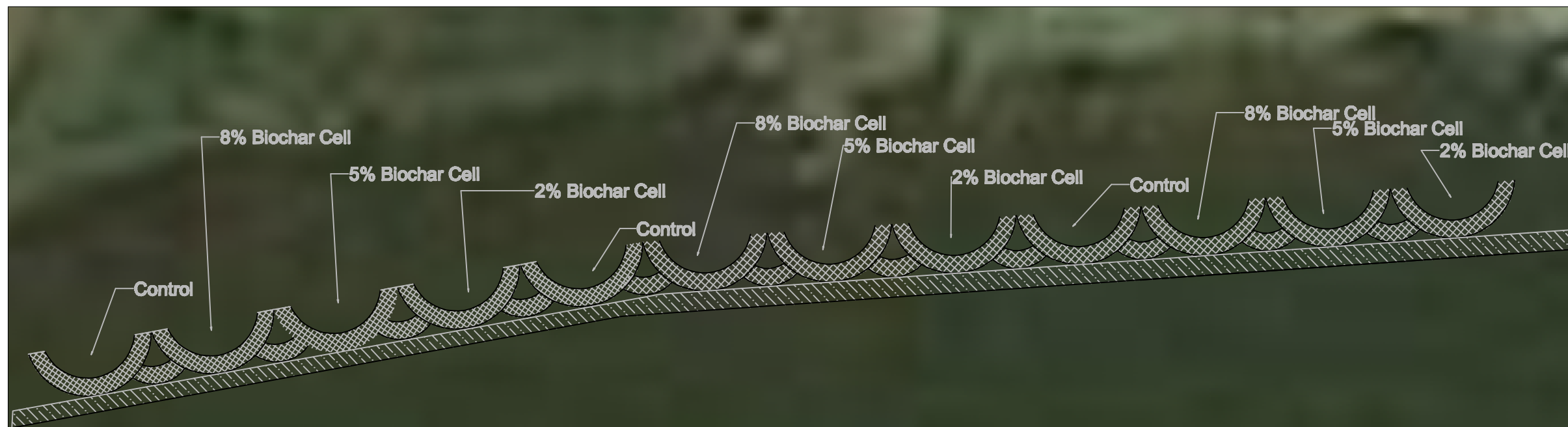
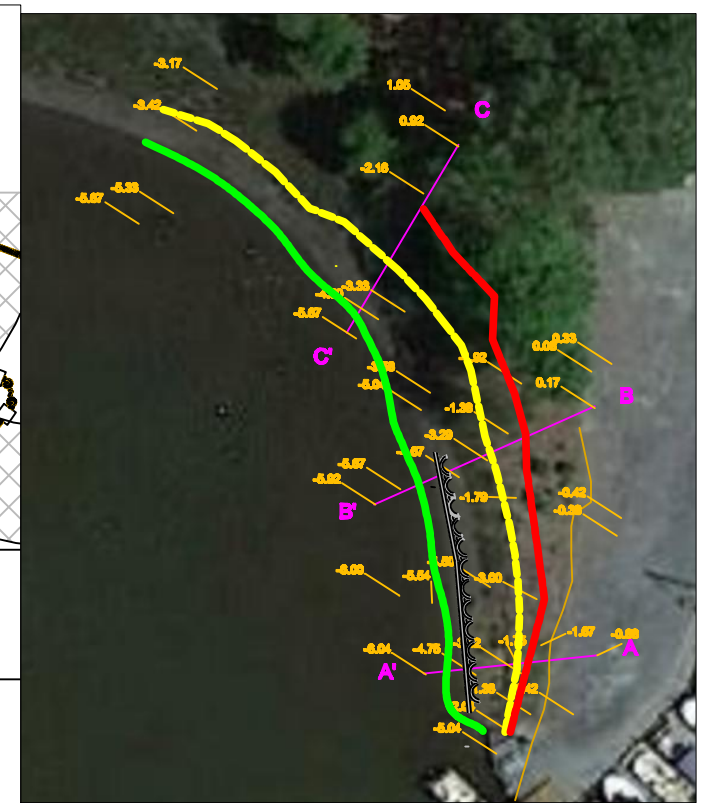
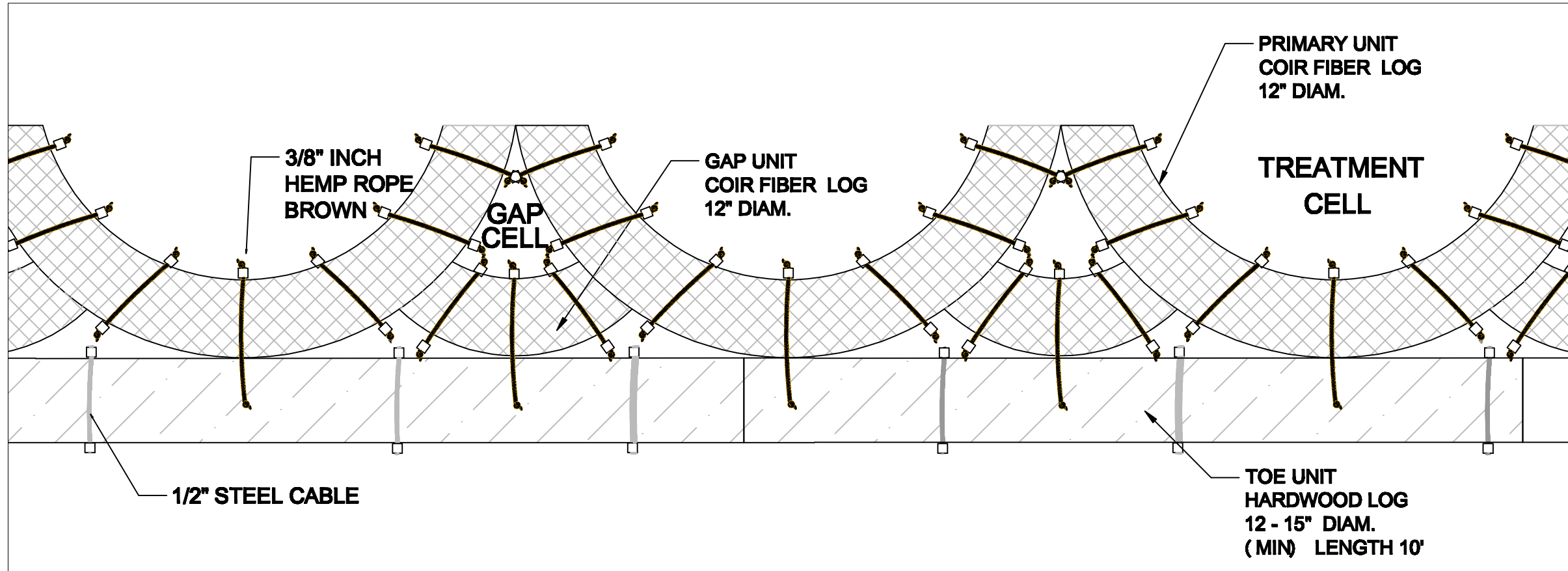



All gap cells will receive five plugs of *Spartina alterflorina* and/or loose plant material from site
 All treatment cells will receive *Spartina alterflorina* at 1 foot off center



ANGOLA BY THE BAY
 23413 BOAT DOCK DRIVE EAST
 LEWES, DELAWARE 19958

DESIGN
 CONVENTIONAL LIVING SHORELINE W/
 HARDWOOD TOE AND TREATMENT

DELAWARE CENTER FOR THE INLAND BAYS

 39375 Inlet Road,
 Rehoboth Beach, DE 19971
 Phone: (302) 228-8105
www.inlandbays.org

SOVEREIGN CONSULTING INC.

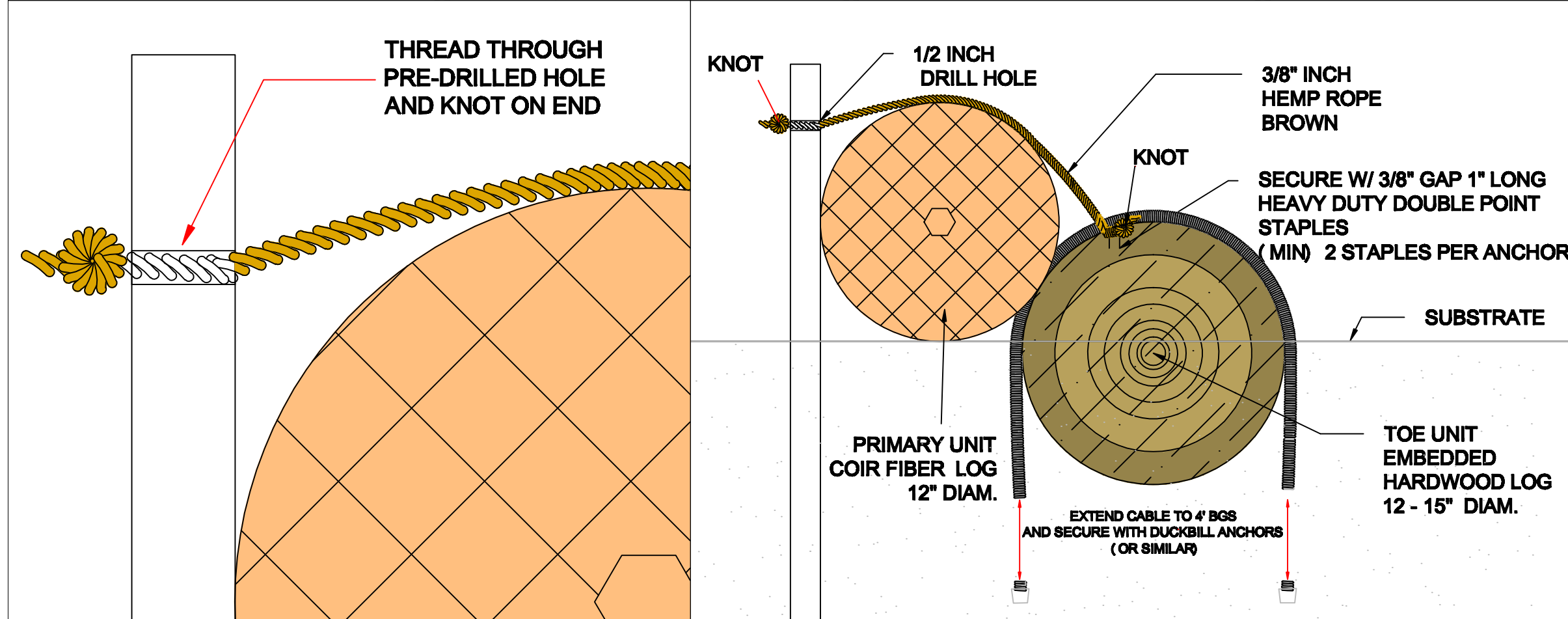
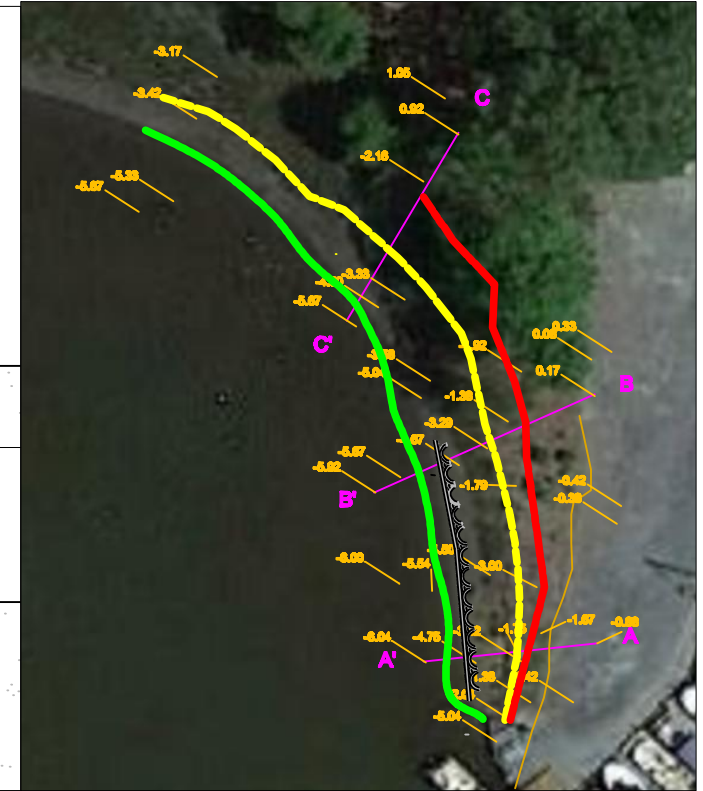
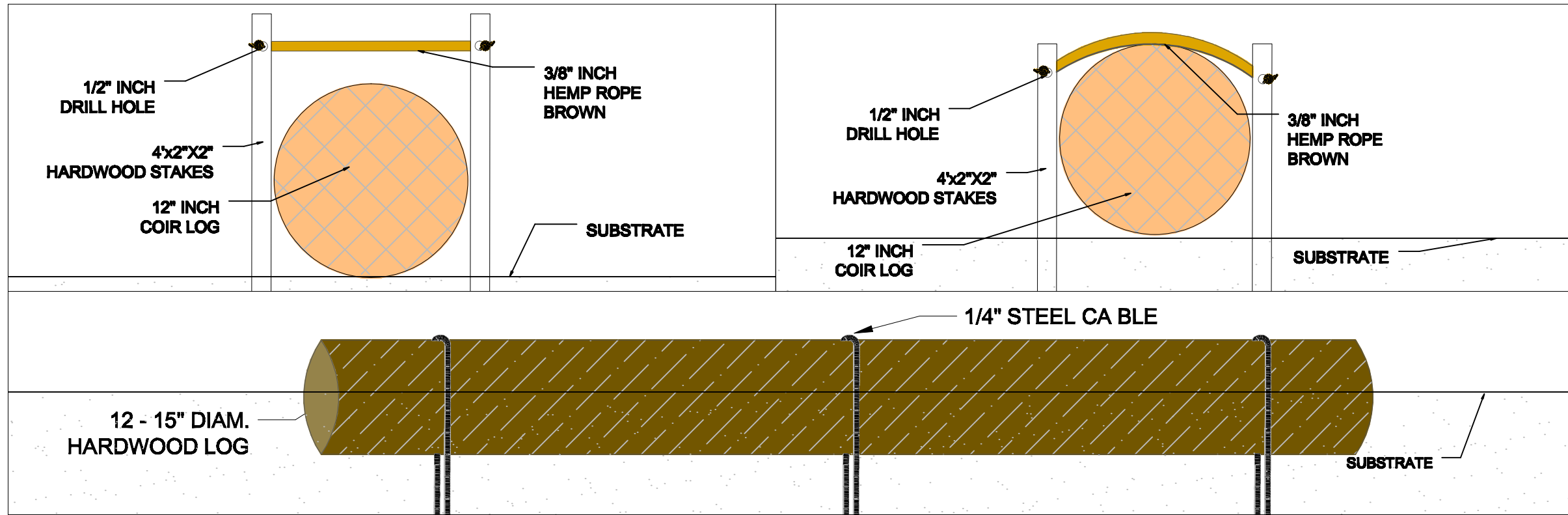
 50 West Welsh Pool Rd., Suite 6
 Exton, Pennsylvania 19341
 Phone: (610) 824-8124 Fax: (610) 824-8129
www.sovcon.com

Created By: DJS	Original: 9/30/16	Figure: 3.2
Revision Date	By	
11.22.16	DJS	
Sheets Affected		ALL



ANGOLA BY THE BAY
 23413 BOAT DOCK DRIVE EAST
 LEWES, DELAWARE 19958

DESIGN DETAILS

DELAWARE CENTER FOR THE INLAND BAYS
 39375 Inlet Road,
 Rehoboth Beach, DE 19971
 Phone: (302) 228-8105
 www.inlandbays.org

SOVEREIGN CONSULTING INC.
 50 West Welsh Pool Rd., Suite 6
 Exton, Pennsylvania 19341
 Phone: (610) 824-8124 Fax: (610) 824-8129
 www.sovcon.com

Created By: DJS	Original: 9/30/16	Figure:
Revision Date	By	Sheets Affected
11.22.16	DJS	ALL

3.3

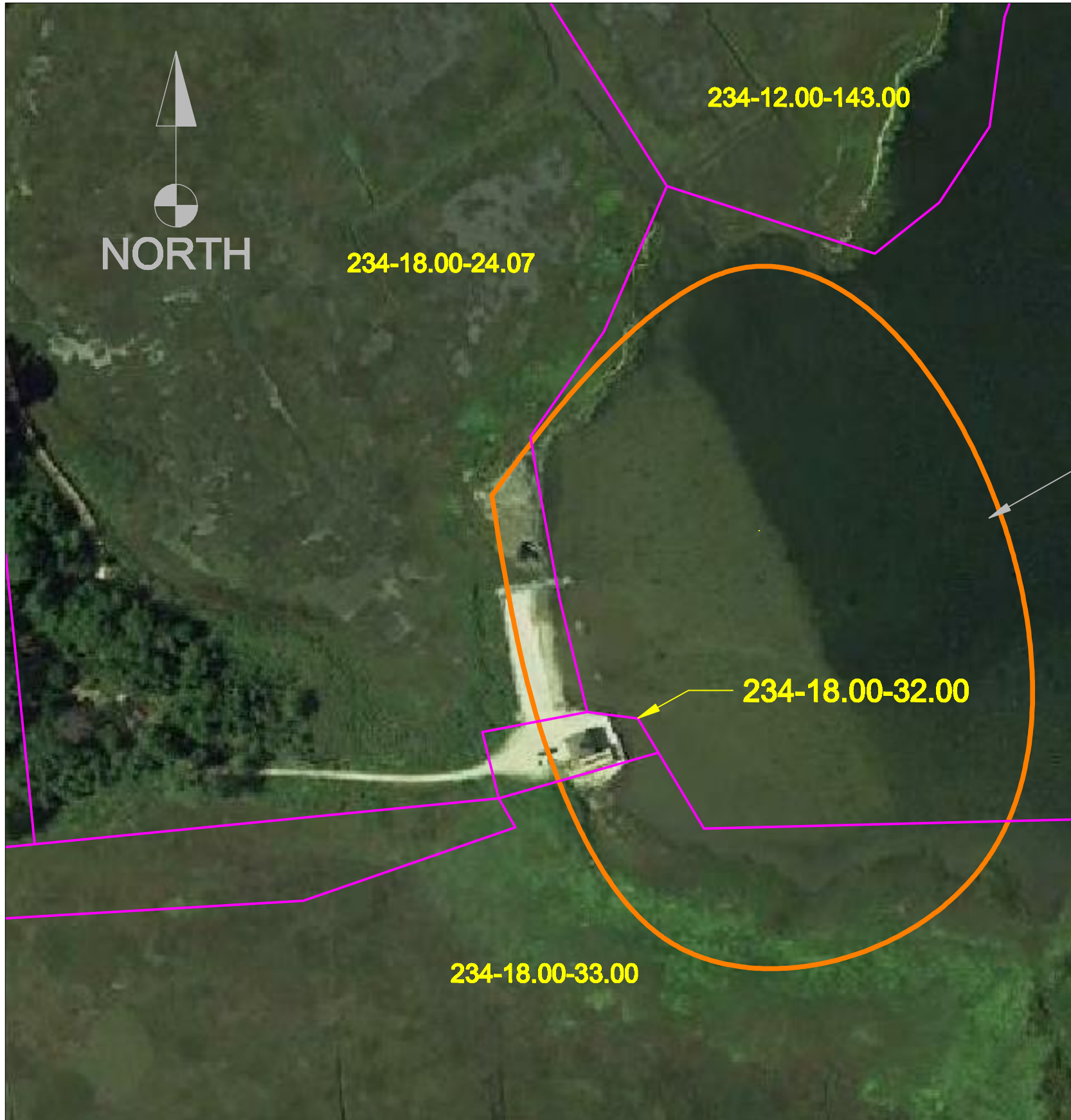

TAX PARCEL NUMBERS.:

Parcel Identification Number	234-12.00-143.00
Parcel Identification Number	234-18.00-24.07
Parcel Identification Number	234-18.00-32.00
Parcel Identification Number	234-18.00-33.00

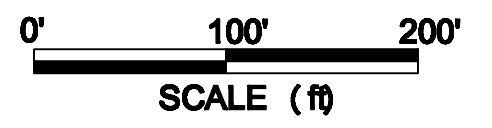

**SHELL LANDING COVE
SHELL LANDING WAY
SUSSEX, DELAWARE 19958**

**DESIGN
SITE LOCATION MAP**

DELAWARE CENTER FOR THE INLAND BAYS

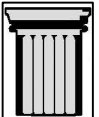
 39375 Inlet Road,
 Rehoboth Beach, DE 19971
 Phone: (302) 228-8105
 www.inlandbays.org

SOVEREIGN CONSULTING INC.

 50 West Welsh Pool Rd., Suite 6
 Exton, Pennsylvania 19341
 Phone: (610) 824-8124 Fax: (610) 824-8129
 www.sovcon.com

Created By: DJS	Original: 9/30/16	Figure: 1.0
Revision Date	By	
11.22.16	DJS	

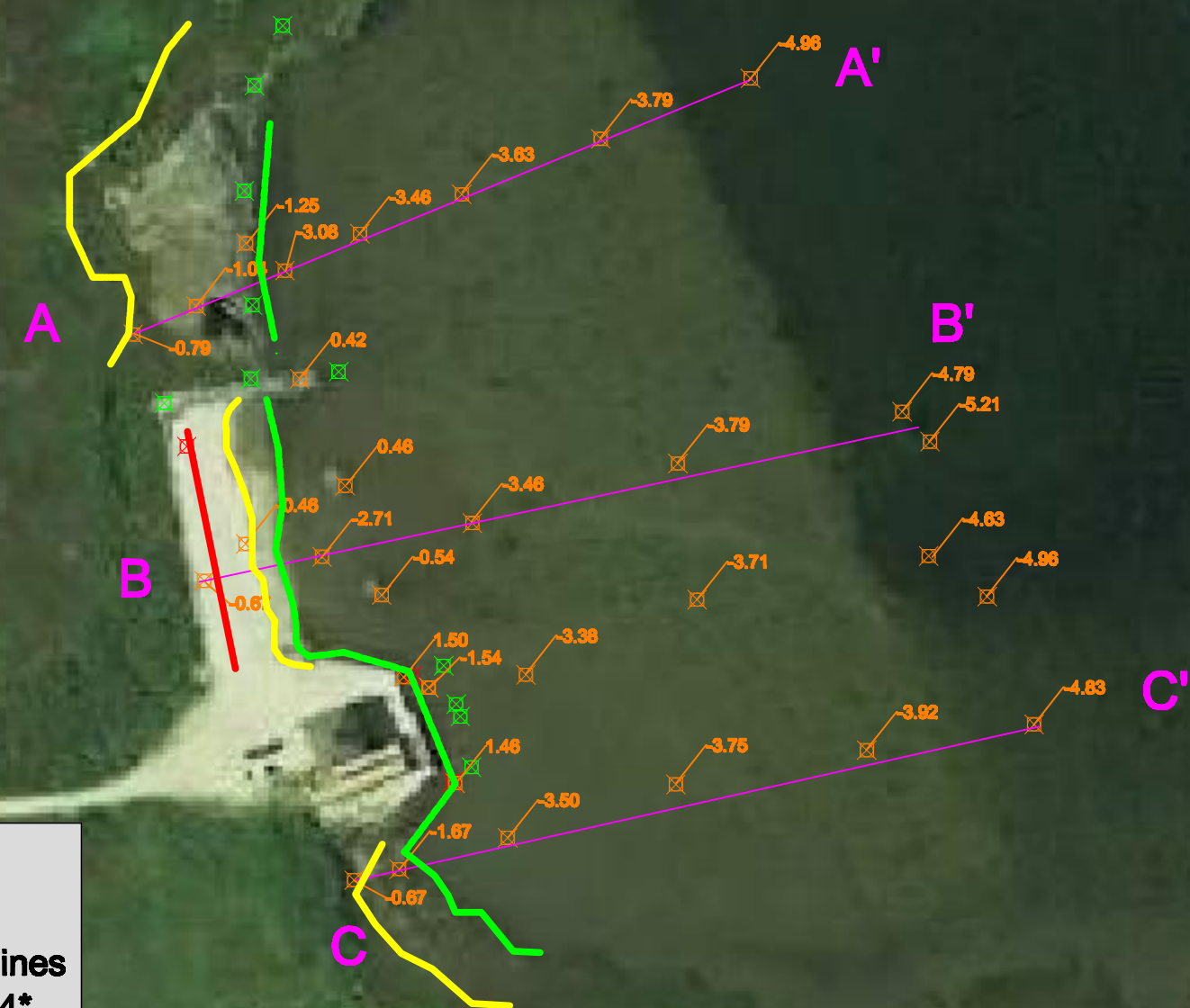
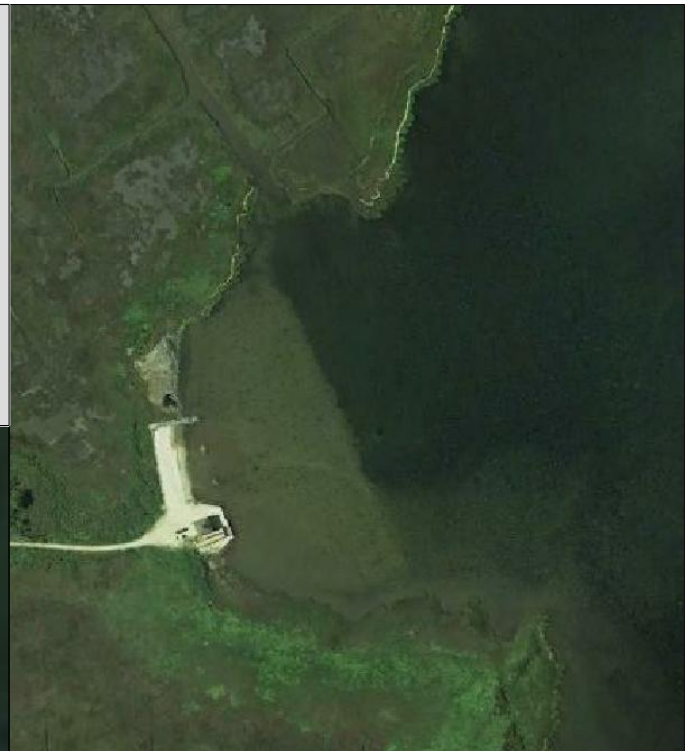

NOTES:

1. THIS PLAN IS ADAPTED FROM DESKTOP INFORMATION AND FIELD MEASUREMENTS COLLECTED BY SOVEREIGN CONSULTING INC., USING A LEVEL LASER, ROD, AND A HAND HELD GPS UNIT.
2. THE LIMITS OF STATE AND FEDERAL JURISDICTION, CONSTITUTING THE MEAN LOW WATER, MEAN HIGH WATER, AND THE HIGH TIDE LINES, AS SHOWN ON THIS PLAN WERE DELINEATED BY SOVEREIGN, CONSULTING, INC., EXTON, PENNSYLVANIA, ON SEPTEMBER 1 AND SEPTEMBER 13, 2016.



*All elevations are site specific elevations tied to a point located within the project area. These elevations do not correspond to any State Plane System

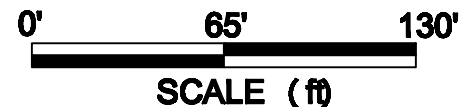

- Survey Points
- Transit Points
- Cross Section Lines
- HTL -0.54*
- MHW -1.21*
- MLW -2.50*

SHELL LANDING COVE SHELL LANDING WAY SUSSEX, DELAWARE 19958		
DESIGN TOPO MAP WITH CROSS SECTION KEY EXISTING CONDITIONS		
DELAWARE CENTER FOR THE INLAND BAYS		
39375 Inlet Road, Rehoboth Beach, DE 19971 Phone: (302) 228-8105 www.inlandbays.org		
SOVEREIGN CONSULTING INC.		
50 West Welsh Pool Rd., Suite 6 Exton, Pennsylvania 19341 Phone: (610) 824-8124 Fax: (610) 824-8129 www.sovcon.com		
Created By: DJS	Original: 9/30/16	Figure:
Revision Date	By	Sheets Affected
11.22.16	DJS	ALL
		2.0

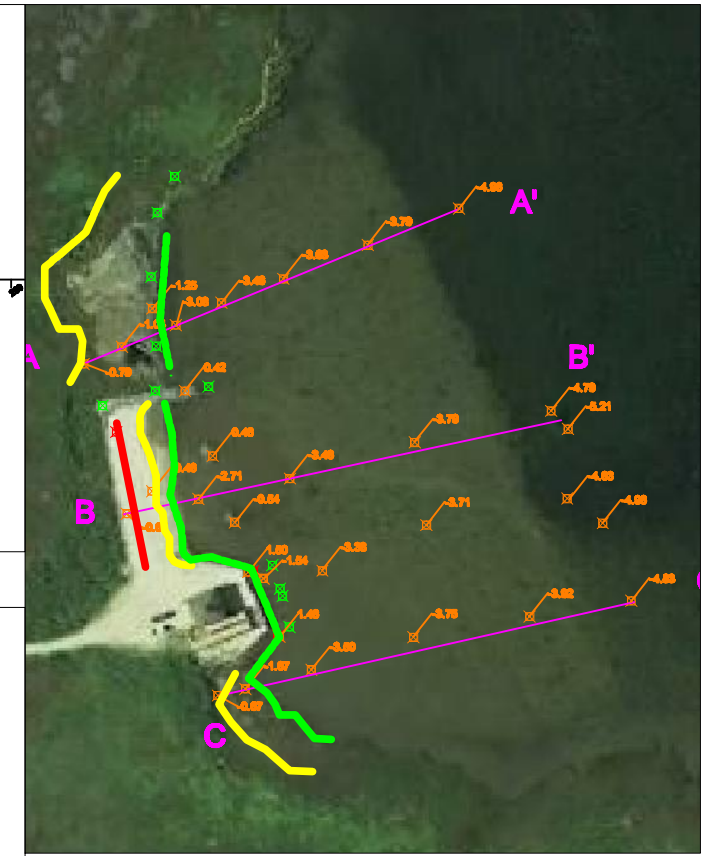
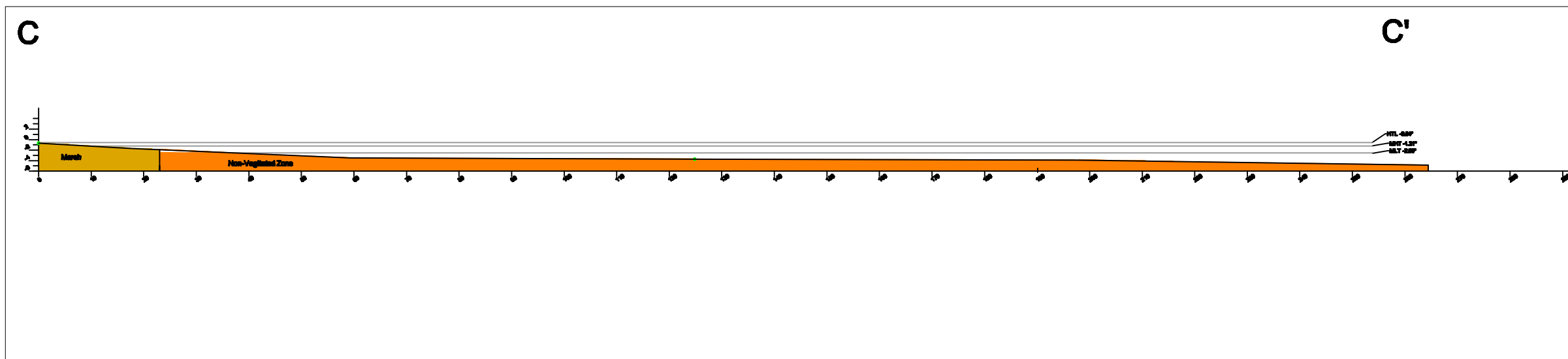
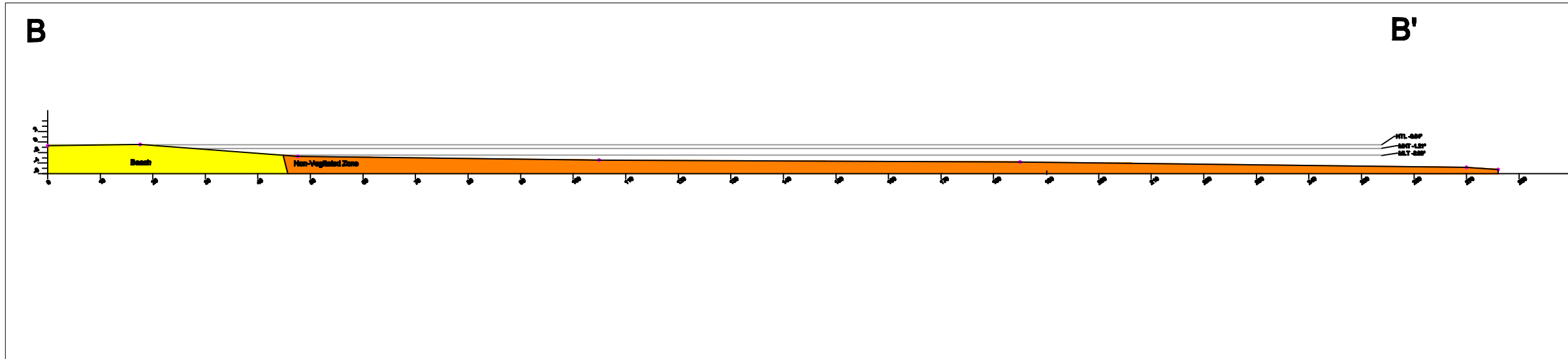
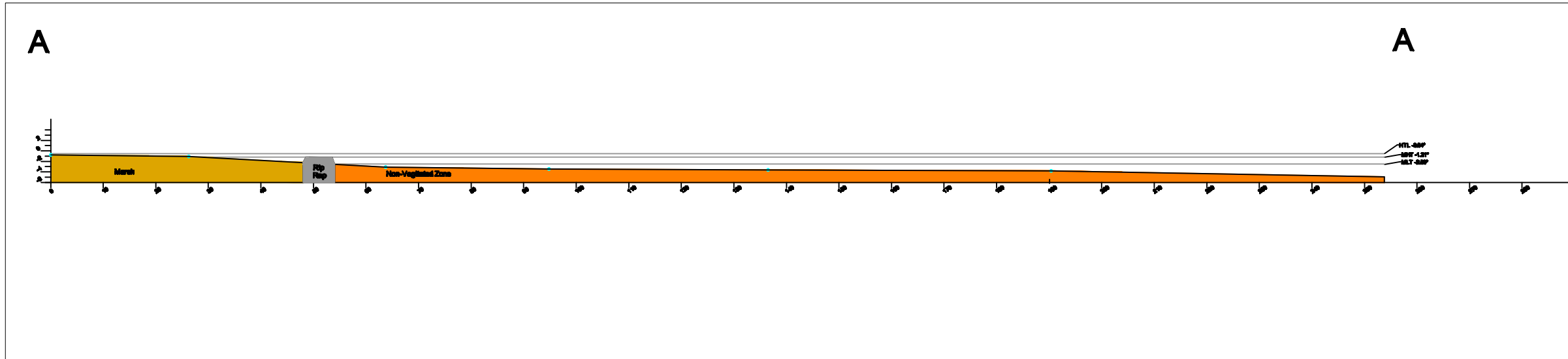

* All elevations are site specific elevations tied to a point located within the project area. These elevations do not correspond to any State Plane System

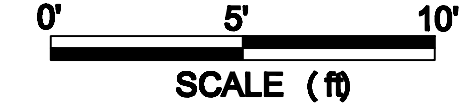

**SHELL LANDING COVE
SHELL LANDING WAY
SUSSEX, DELAWARE 19958**

**CROSS SECTIONS A THROUGH C
EXISTING CONDITIONS**

DELAWARE CENTER FOR THE INLAND BAYS
39375 Inlet Road,
Rehoboth Beach, DE 19971
Phone: (302) 228-8105
www.inlandbays.org

SOVEREIGN CONSULTING INC.
50 West Welsh Pool Rd., Suite 6
Exton, Pennsylvania 19341
Phone: (610) 824-8124 Fax: (610) 824-8129
www.sovcon.com

Created By: DJS	Original: 9/30/16	Figure: 2.1
Revision Date	By	
11.22.16	DJS	



MATERIAL VOLUME ESTIMATES:	
UNIT DESCRIPTION	NUMBER OF UNITS
WADS (3.5' TALL , 5.5' WIDE)	268
PERMANENT MARKING BUOY	6

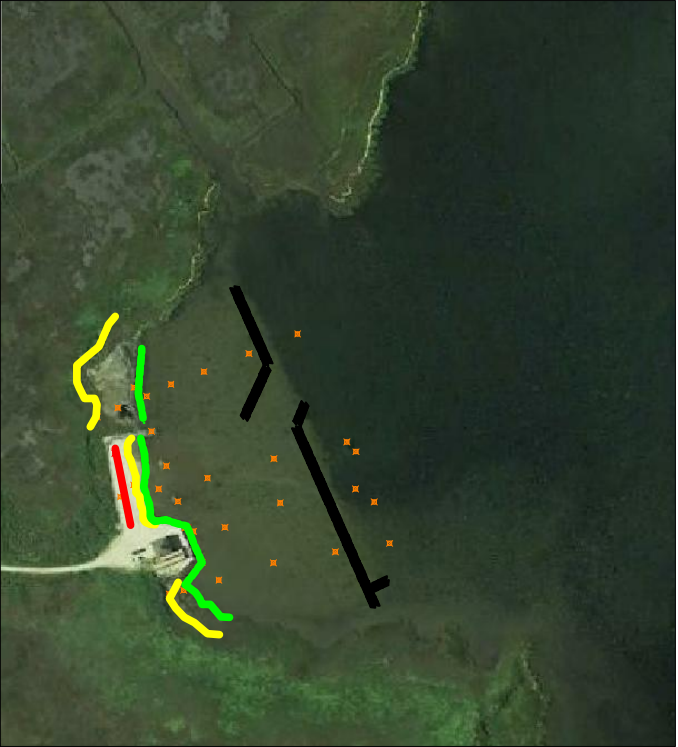

*All elevations are site specific elevations tied to a point located within the project area. These elevations do not correspond to any State Plane System

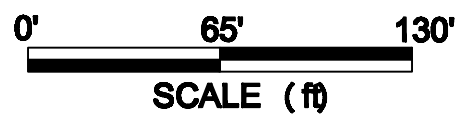







**SHELL LANDING COVE
SHELL LANDING WAY
SUSSEX, DELAWARE 19958
DESIGN
ENERGY ATTENUATION REEF
USING WADS ®**

DELAWARE CENTER FOR THE INLAND BAYS

 39375 Inlet Road,
 Rehoboth Beach, DE 19971
 Phone: (302) 228-8105
 www.inlandbays.org

SOVEREIGN CONSULTING INC.

 50 West Welsh Pool Rd., Suite 6
 Exton, Pennsylvania 19341
 Phone: (610) 824-8124 Fax: (610) 824-8129
 www.sovcon.com

 Buoy
 Survey Points
 Wads
 HTL -0.54*
 MHW -1.21*
 MLW -2.50*

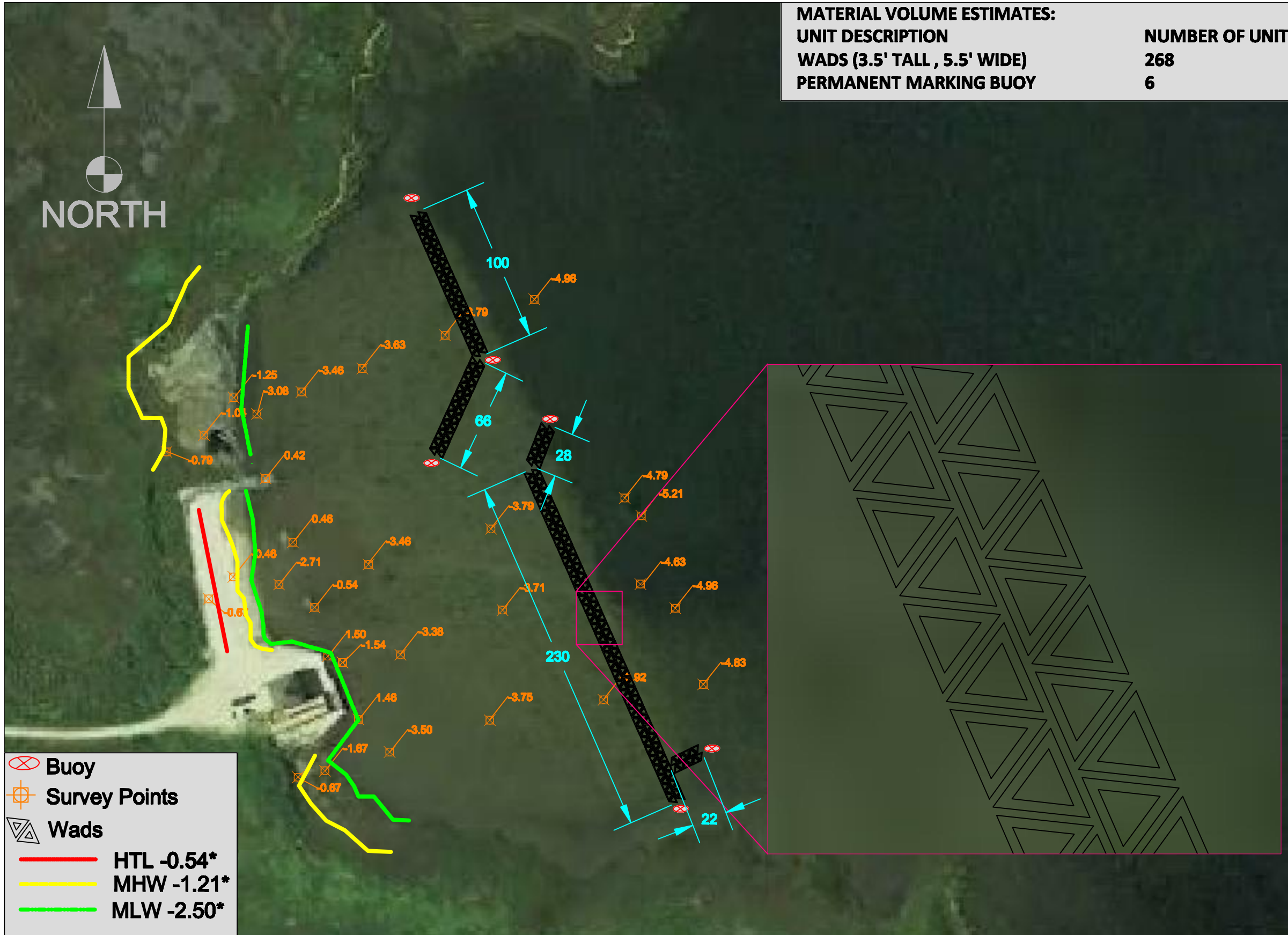

Created By: DJS	Original: 9/30/16	Figure: 3.0
Revision Date 11.22.16	By DJS	
	Sheets Affected ALL	

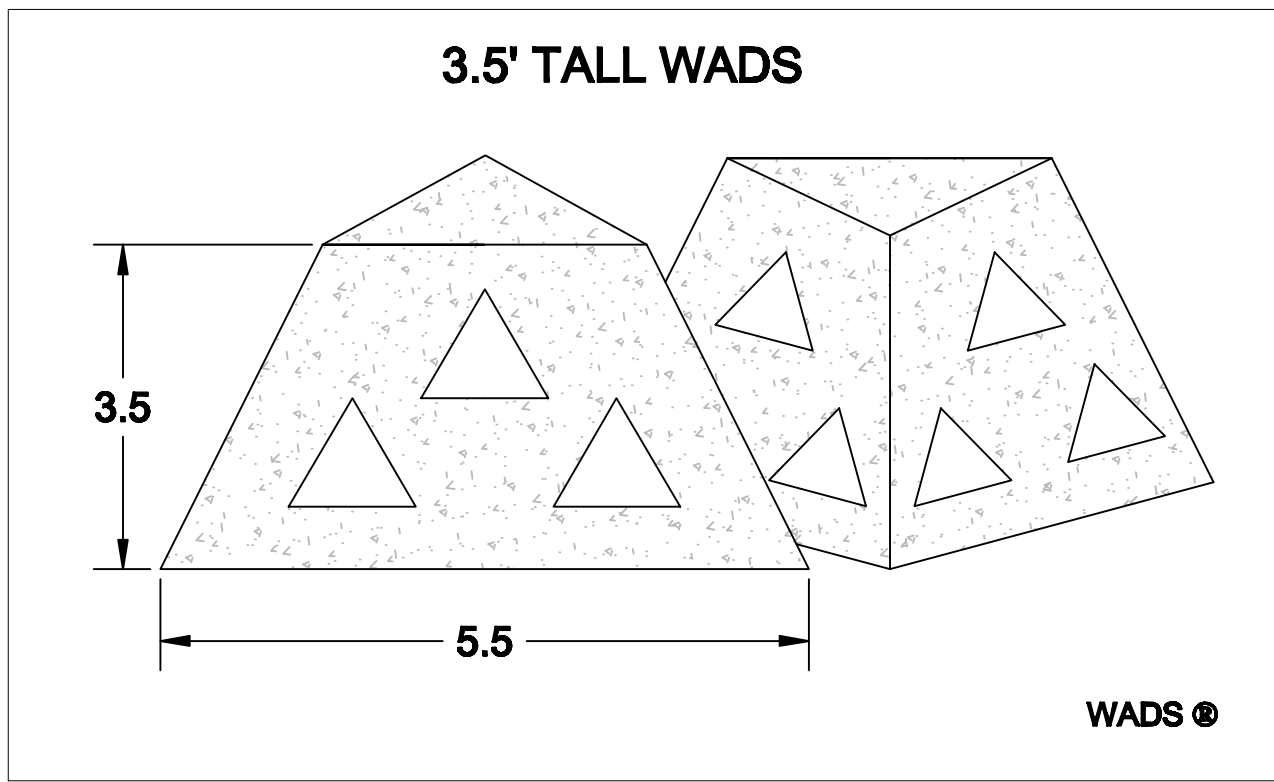
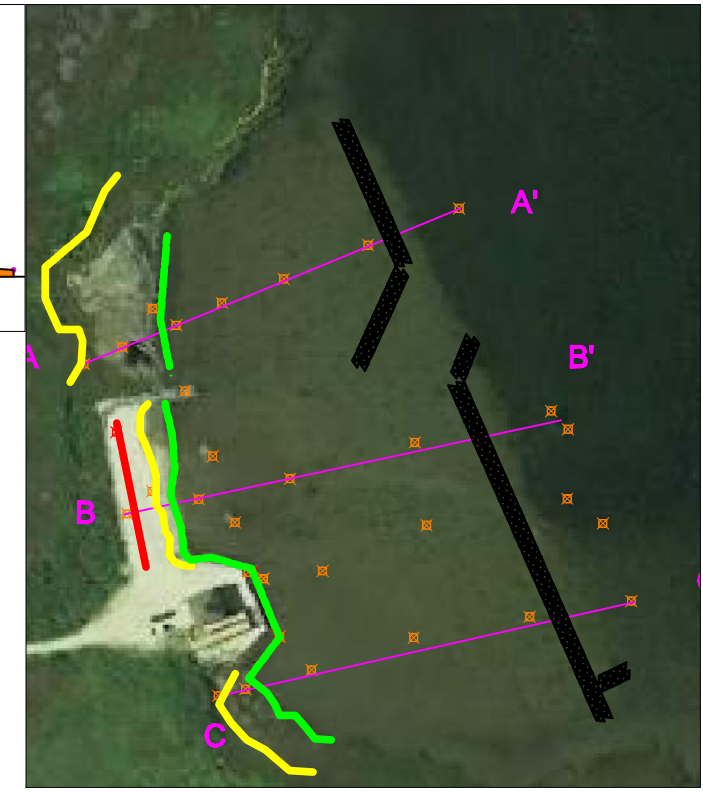
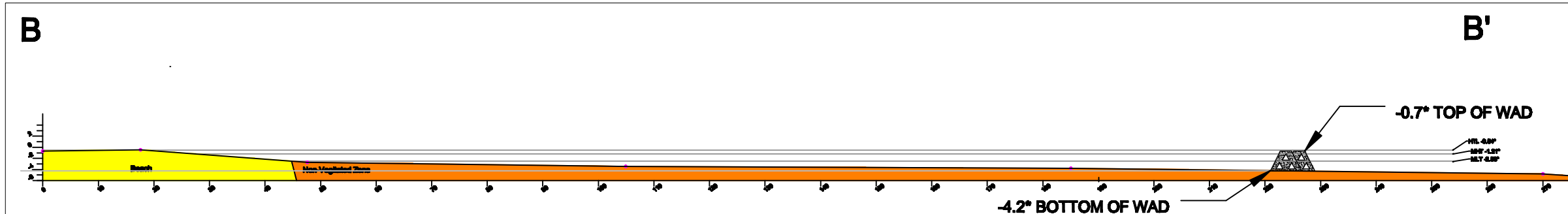

*All elevations are site specific elevations tied to a point located within the project area. These elevations do not correspond to any State Plane System

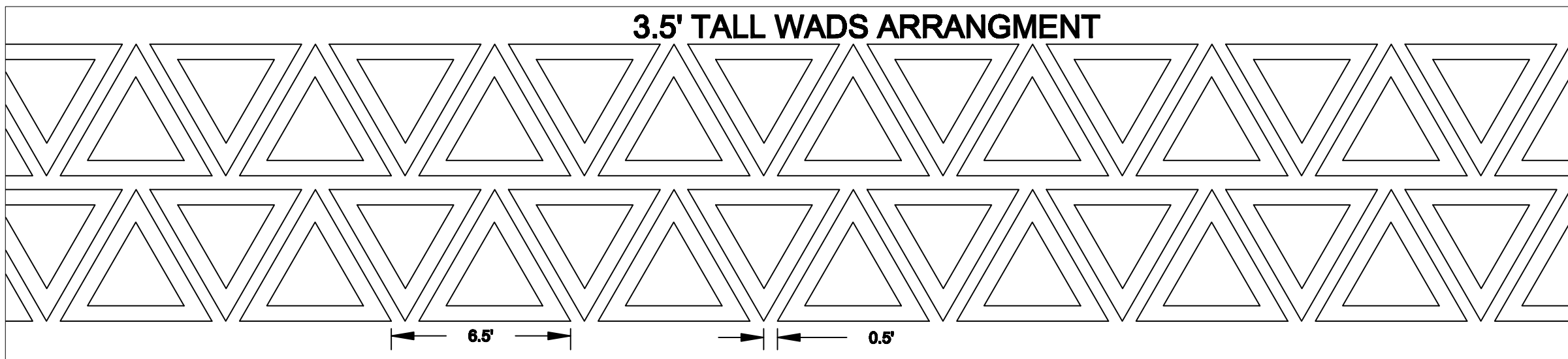

**SHELL LANDING COVE
SHELL LANDING WAY
SUSSEX, DELAWARE 19958**

**DESIGN
REEF
DETAIL**

DELAWARE CENTER FOR THE INLAND BAYS

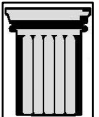
 39375 Inlet Road,
 Rehoboth Beach, DE 19971
 Phone: (302) 228-8105
 www.inlandbays.org

SOVEREIGN CONSULTING INC.

 50 West Welsh Pool Rd., Suite 6
 Exton, Pennsylvania 19341
 Phone: (610) 824-8124 Fax: (610) 824-8129
 www.sovcon.com

Created By: DJS	Original: 9/30/16	Figure:
Revision Date	By	Sheets Affected
11.22.16	DJS	ALL

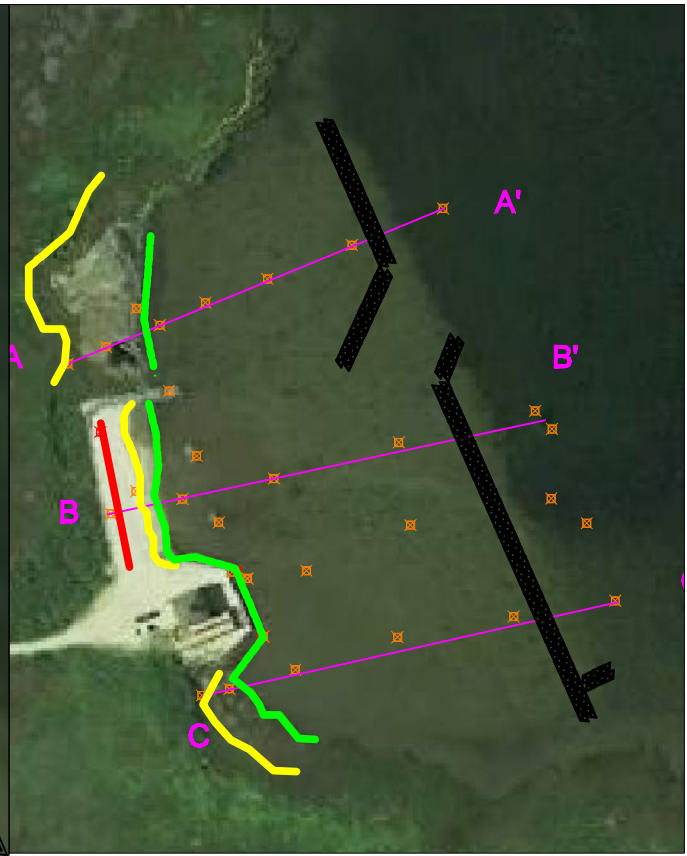
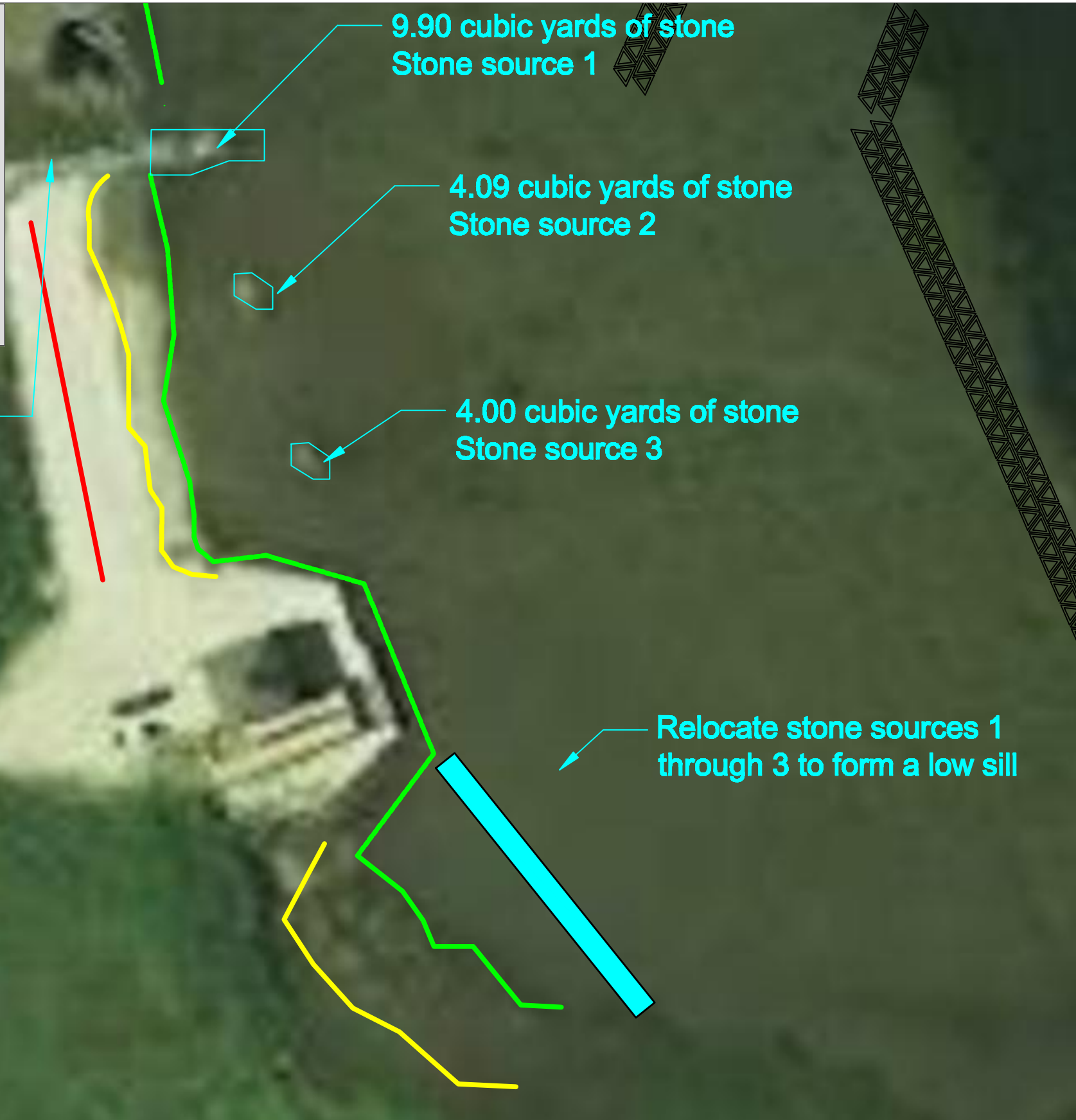
3.1

NOTES:
 1.) DETAILS ON THIS SHEET WERE DEVELOPED AT THE REQUEST OF THE CENTER FOR INLAND BAYS. THE PURPOSE WAS TO PROVIDE AN OPTION FOR THE BENEFICIAL REUSE OF CERTAIN STONE WHICH WOULD NO LONGER BE NECESSARY ONCE THE WAD REEF IS IN PLACE. FIGURE 3.2 HAS BEEN PREPARED IN RESPONSE TO THE REQUEST.
 2.) ALL VOLUMES WERE ESTIMATED UPON THE EVALUATION OF GROUND PHOTOGRAPHY, AERIAL PHOTOGRAPHY AND LIMITED RELATIVE SURVEY DATA.
 3.) PROPOSED TOP OF NEW SILL, BASED ON THE ESTIMATED VOLUME AND ELEVATION, WOULD BE AT AN APPROXIMATE RELATIVE ELEVATION OF -1.5* FEET.



* All elevations are site specific elevations tied to a point located within the project area. These elevations do not correspond to any State Plane System

**SHELL LANDING COVE
 SHELL LANDING WAY
 SUSSEX, DELAWARE 19958**

**DESIGN
 SHORELINE IMPROVEMENTS
 PLAN VIEW**

DELAWARE CENTER FOR THE INLAND BAYS
 39375 Inlet Road,
 Rehoboth Beach, DE 19971
 Phone: (302) 228-8105
 www.inlandbays.org

SOVEREIGN CONSULTING INC.
 50 West Welsh Pool Rd., Suite 6
 Exton, Pennsylvania 19341
 Phone: (610) 824-8124 Fax: (610) 824-8129
 www.sovcon.com

Created By: DJS	Original: 9/30/16	Figure:
Revision Date	By	Sheets Affected
11.22.16	DJS	ALL

3.2



PROJECT AREA



334-25.00-11.00

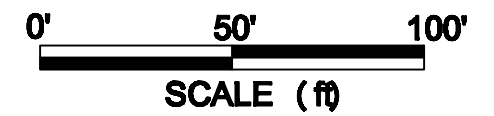

INLET ROAD EAST
39401 INLET ROAD
REHOBOTH BEACH, DELAWARE 19971

DESIGN
SITE LOCATION MAP

DELAWARE CENTER FOR THE INLAND BAYS
39375 Inlet Road,
Rehoboth Beach, DE 19971
Phone: (302) 228-8108
www.inlandbays.org

 **SOVEREIGN CONSULTING INC.**
50 West Welsh Pool Rd., Suite 6
Exton, Pennsylvania 19341
Phone: (610) 524-8124 Fax: (610) 524-8129
www.sovcon.com

TAX PARCEL NUMBERS.:
Parcel Identification Number 334-25.00-11.00

Created By: DJS	Original: 9/21/16	Figure: 1.0
Revision Date	By	
11/17/16	DJS	1.0 & 3.0

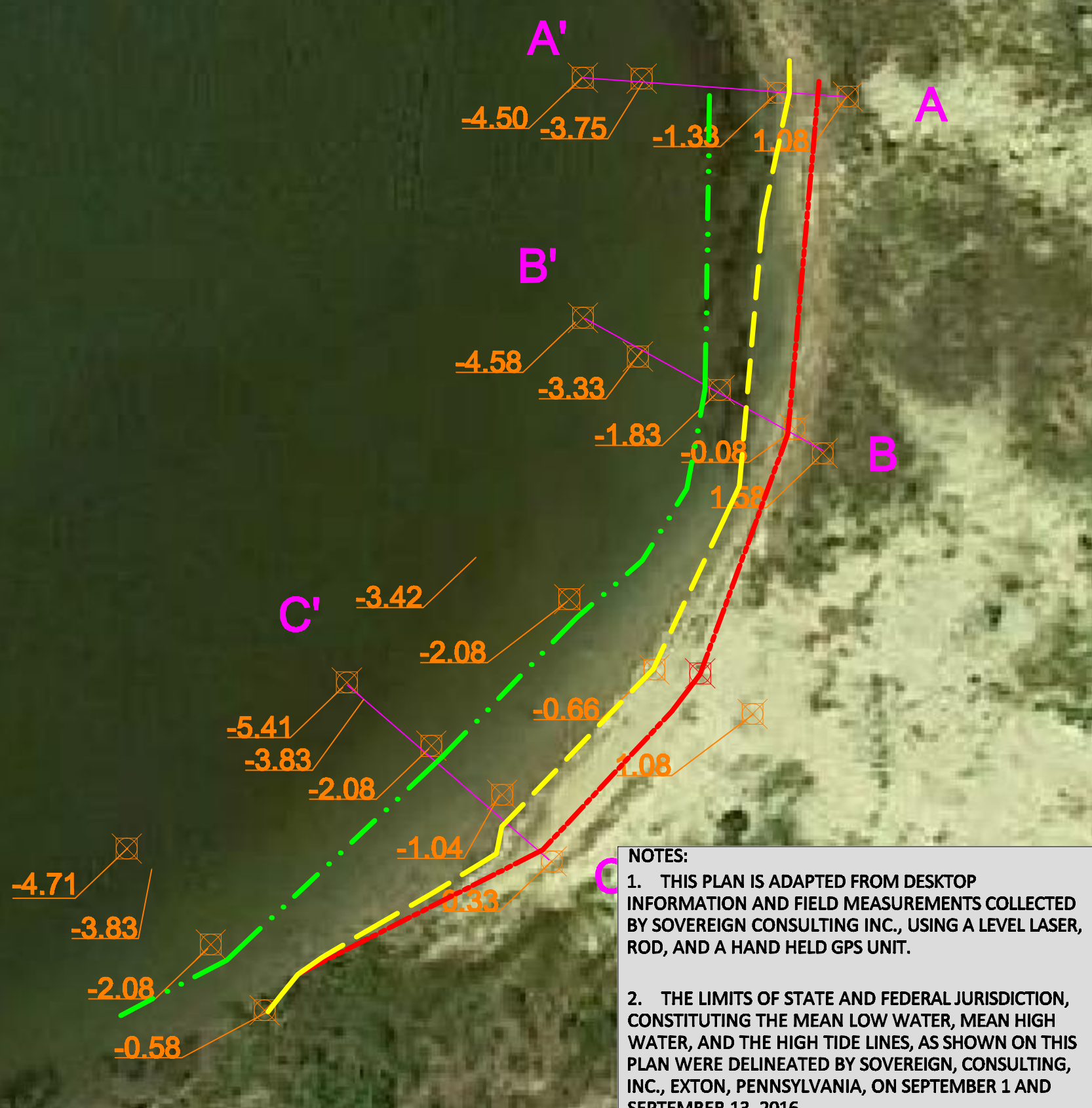
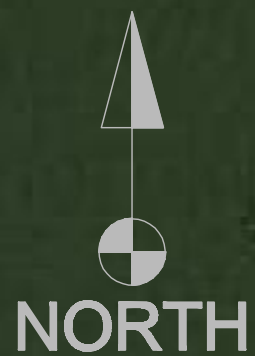

- Survey Points
- Transit Points
- Cross Section Lines
- HTL -0.00*
- MHW -0.66*
- MLW -1.89*

NOTES:

- THIS PLAN IS ADAPTED FROM DESKTOP INFORMATION AND FIELD MEASUREMENTS COLLECTED BY SOVEREIGN CONSULTING INC., USING A LEVEL LASER, ROD, AND A HAND HELD GPS UNIT.
- THE LIMITS OF STATE AND FEDERAL JURISDICTION, CONSTITUTING THE MEAN LOW WATER, MEAN HIGH WATER, AND THE HIGH TIDE LINES, AS SHOWN ON THIS PLAN WERE DELINEATED BY SOVEREIGN, CONSULTING, INC., EXTON, PENNSYLVANIA, ON SEPTEMBER 1 AND SEPTEMBER 13, 2016.



*All elevations are site specific elevations tied to a point located within the project area. These elevations do not correspond to any State Plane System

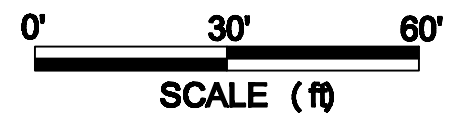

INLET ROAD EAST		
39401 INLET ROAD		
REHOBOTH BEACH, DELAWARE 19971		
DESIGN		
TOPO MAP WITH CROSS SECTION KEY		
EXISTING CONDITIONS		
DELAWARE CENTER FOR THE INLAND BAYS		
39375 Inlet Road, Rehoboth Beach, DE 19971 Phone: (302) 228-8108 www.inlandbays.org		
SOVEREIGN CONSULTING INC.		
50 West Welsh Pool Rd., Suite 6 Exton, Pennsylvania 19341 Phone: (610) 524-8124 Fax: (610) 524-8129 www.sovcon.com		
Created By: DJS	Original: 9/21/16	Figure:
Revision Date: 11.22.16	By: DB	Sheets Affected: ALL
		2.0

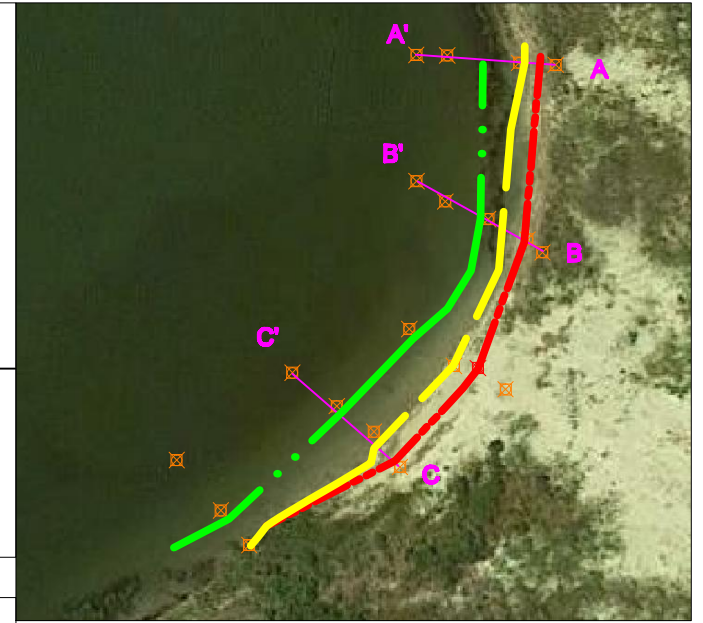
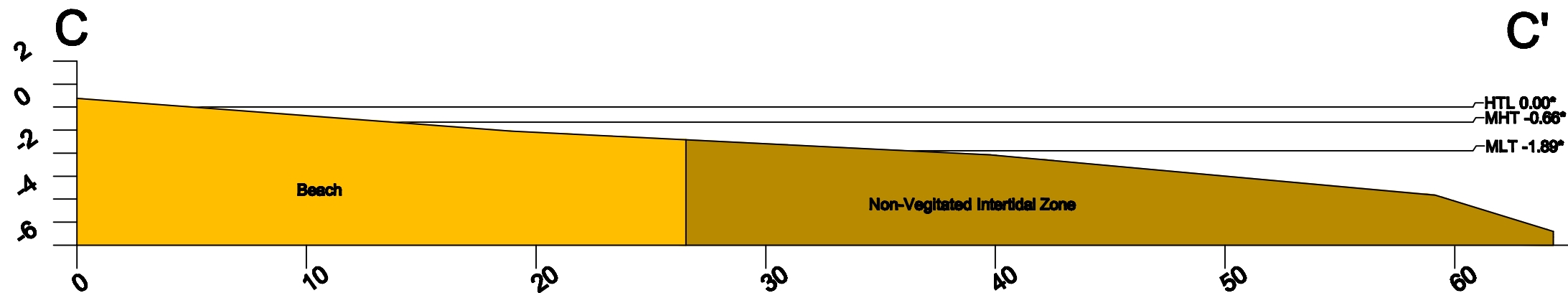
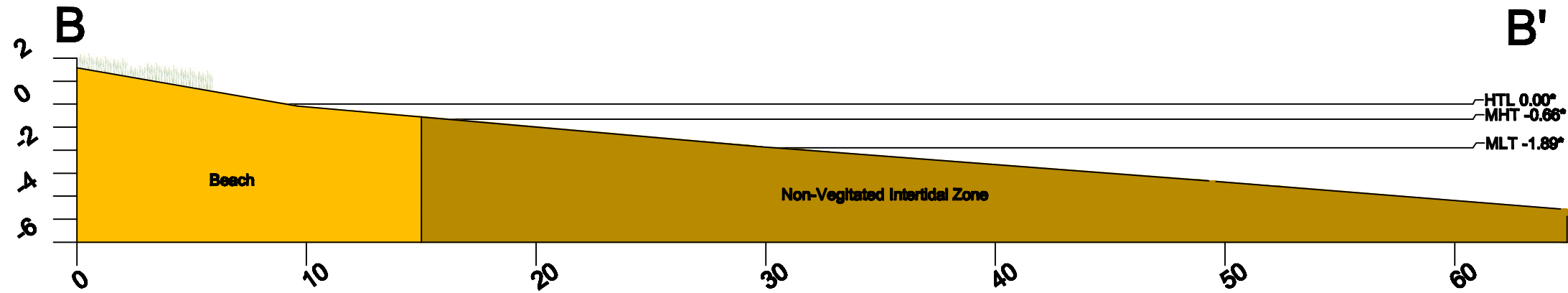
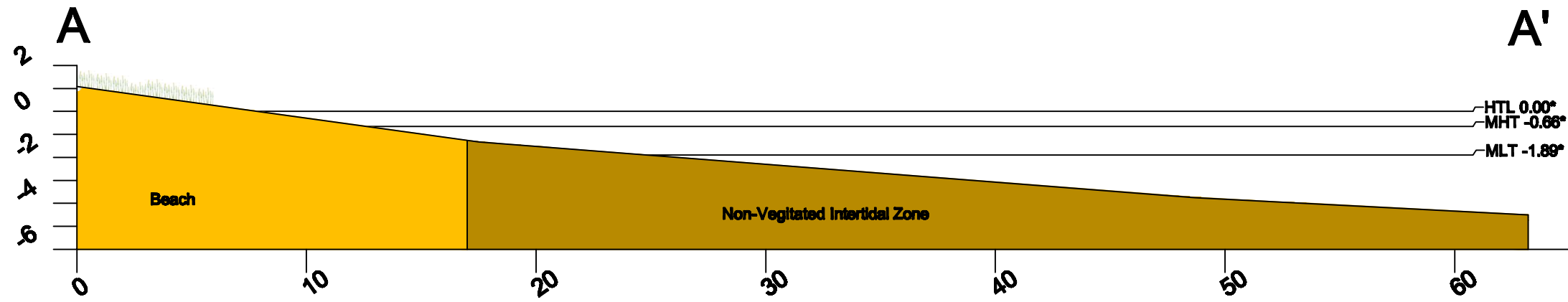

*All elevations are site specific elevations tied to a point located within the project area. These elevations do not correspond to any State Plane System

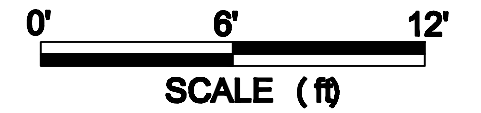

**INLET ROAD EAST
39401 INLET ROAD
REHOBOTH BEACH, DELAWARE 19971**

**CROSS SECTIONS A THROUGH C
EXISTING CONDITIONS**

DELAWARE CENTER FOR THE INLAND BAYS

 39375 Inlet Road,
 Rehoboth Beach, DE 19971
 Phone: (302) -228-8108
www.inlandbays.org

SOVEREIGN CONSULTING INC.
 50 West Welsh Pool Rd., Suite 6
 Exton, Pennsylvania 19341
 Phone: (610) 524-8124 Fax: (610) 524-8129
www.sovcon.com

Created By: DJS	Original: 9/21/16	Figure: 2.1
Revision Date	By Sheets Affected	
11.22.16	DJS ALL	



200 FOOT LENGTH

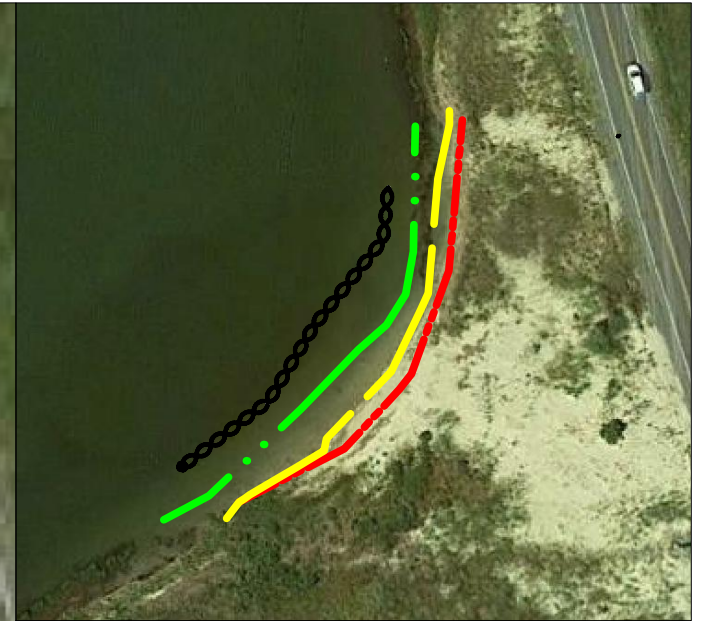
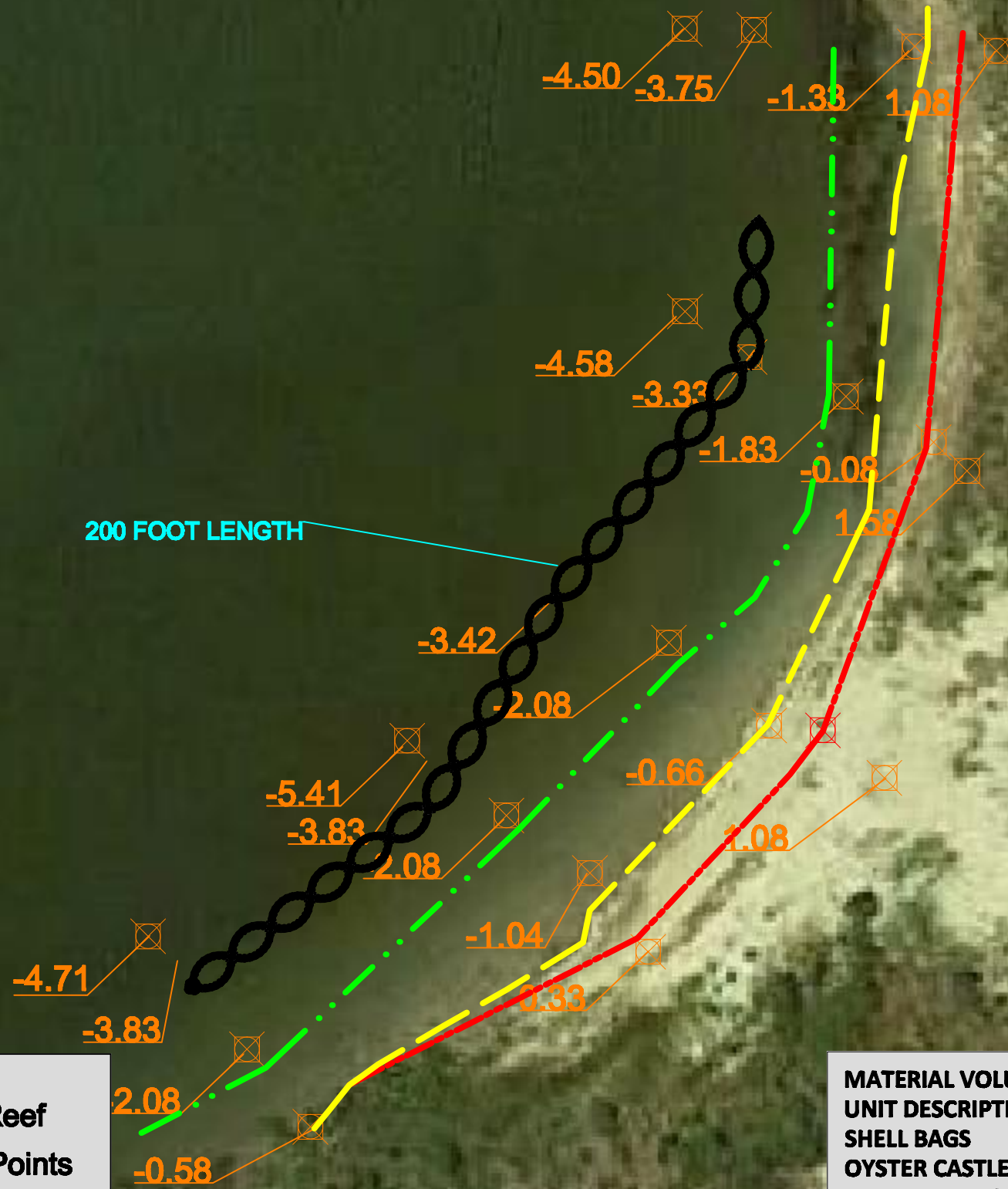

*All elevations are site specific elevations tied to a point located within the project area. These elevations do not correspond to any State Plane System

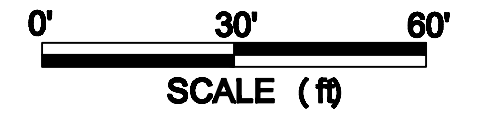

INLET ROAD EAST
39401 INLET ROAD
REHOBOTH BEACH, DELAWARE 19971

DESIGN
BRAIDED OYSTER REEF TACTIC
PLAN VIEW

DELAWARE CENTER FOR THE INLAND BAYS
 39375 Inlet Road,
 Rehoboth Beach, DE 19971
 Phone: (302) -228-8108
 www.inlandbays.org

SOVEREIGN CONSULTING INC.
 50 West Welsh Pool Rd., Suite 6
 Exton, Pennsylvania 19341
 Phone: (610) 524-8124 Fax: (610) 524-8129
 www.sovcon.com

Created By: DJS	Original: 9/21/16	Figure: 3.0
Revision Date	By	
11.22.16	DJS	

- Oyster Reef
- Survey Points
- HTL -0.00*
- MHW -0.66*
- MLW -1.89*

MATERIAL VOLUME ESTIMATES:	
UNIT DESCRIPTION	NUMBER OF UNITS
SHELL BAGS	520
OYSTER CASTLE	105
COIR MAT 90 (3.28' X 83')	374
DUCKBILL EARTH ANCHOR MODEL 68	360
HAMMER PROBE WITH EXTENSION AND CONNECTOR	2
NYLON ROPE (FEET)	1240

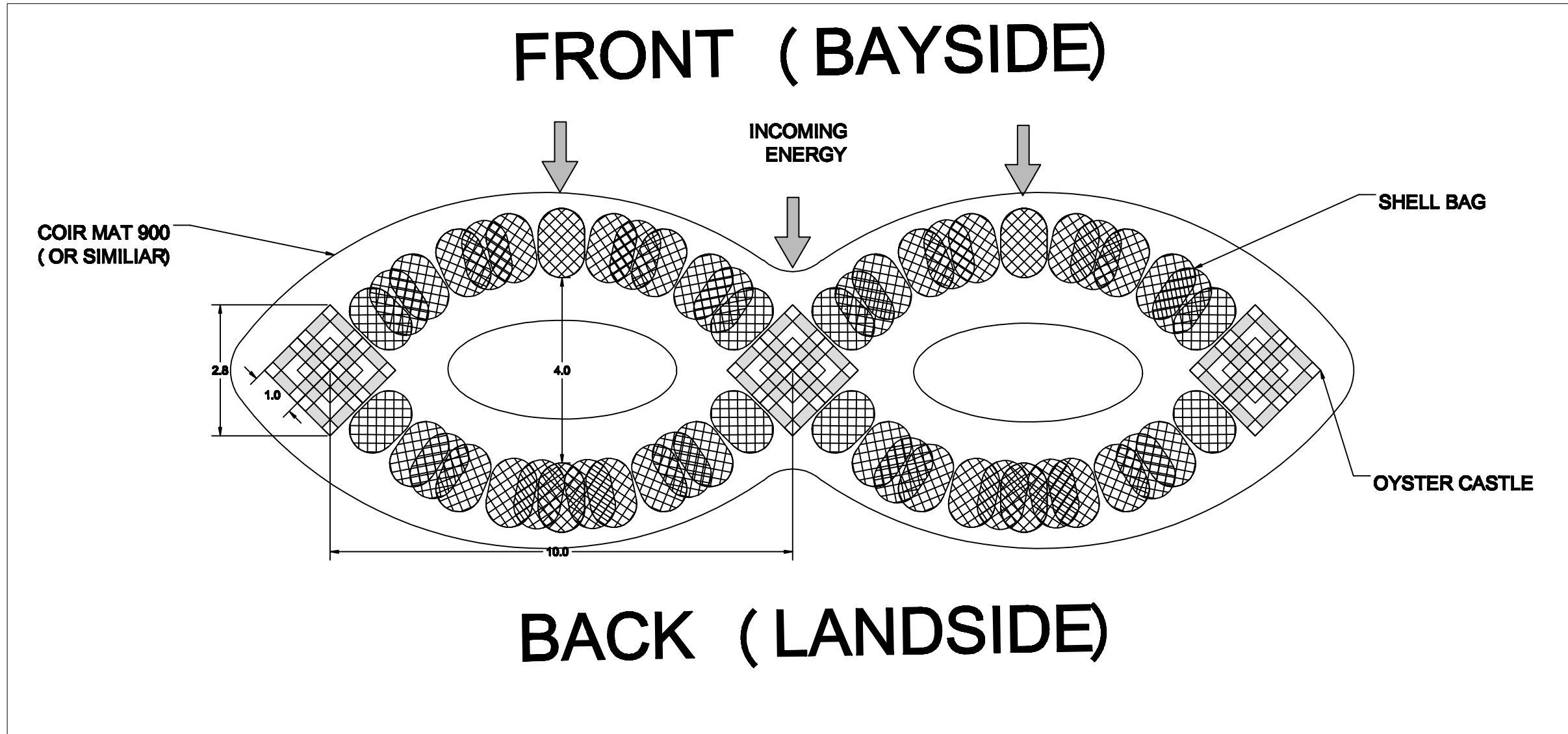
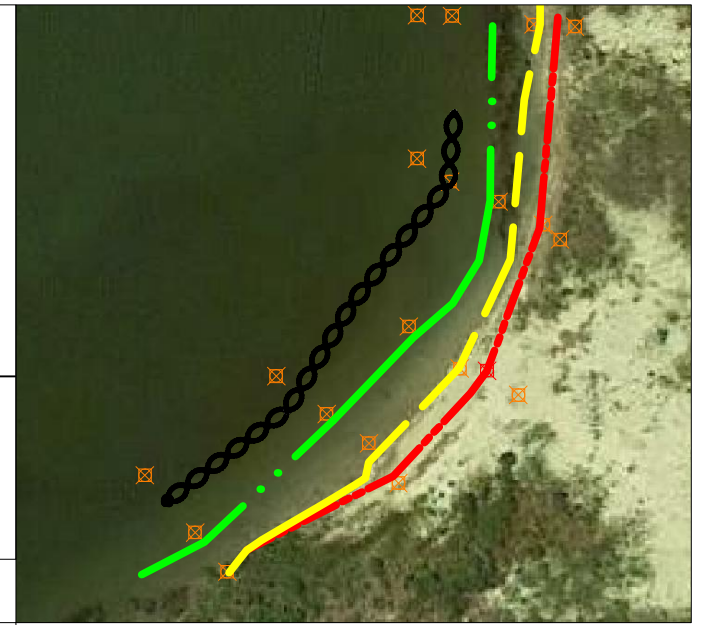
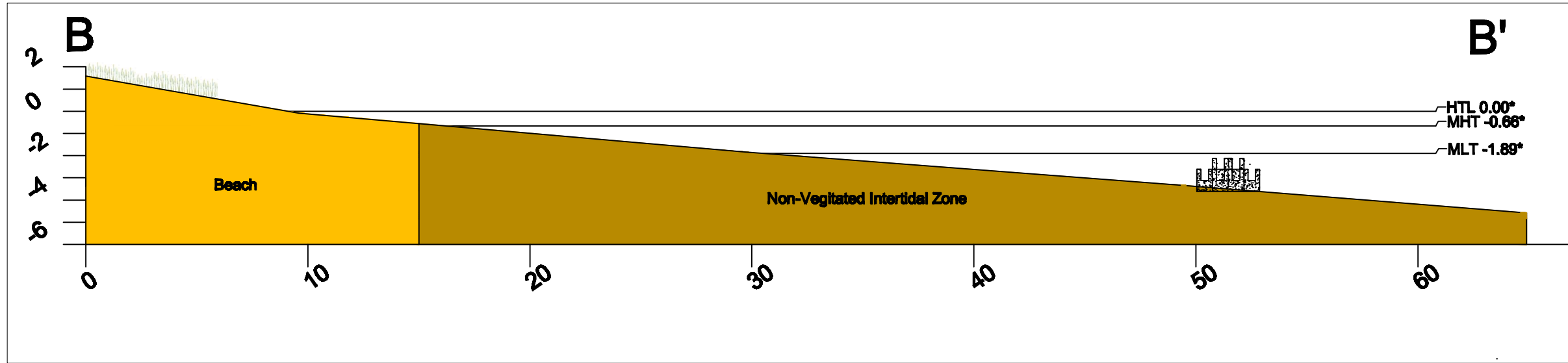

INLET ROAD EAST
39401 INLET ROAD
REHOBOTH BEACH, DELAWARE 19971

DESIGN
BRAIDED REEF
DETAIL

DELAWARE CENTER FOR THE INLAND BAYS
39375 Inlet Road,
Rehoboth Beach, DE 19971
Phone: (302) -228-8108
www.inlandbays.org

SOVEREIGN CONSULTING INC.
50 West Welsh Pool Rd., Suite 6
Exton, Pennsylvania 19341
Phone: (610) 524-8124 Fax: (610) 524-8129
www.sovcon.com

Created By: DJS	Original: 9/30/16	Figure:
Revision Date	By	Sheets Affected
11.22.16	DJS	ALL

3.1

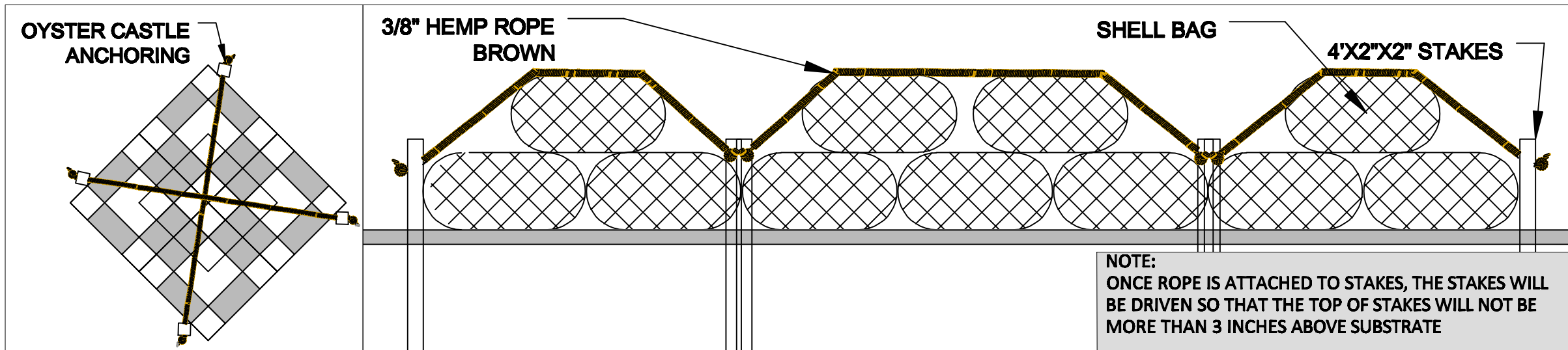
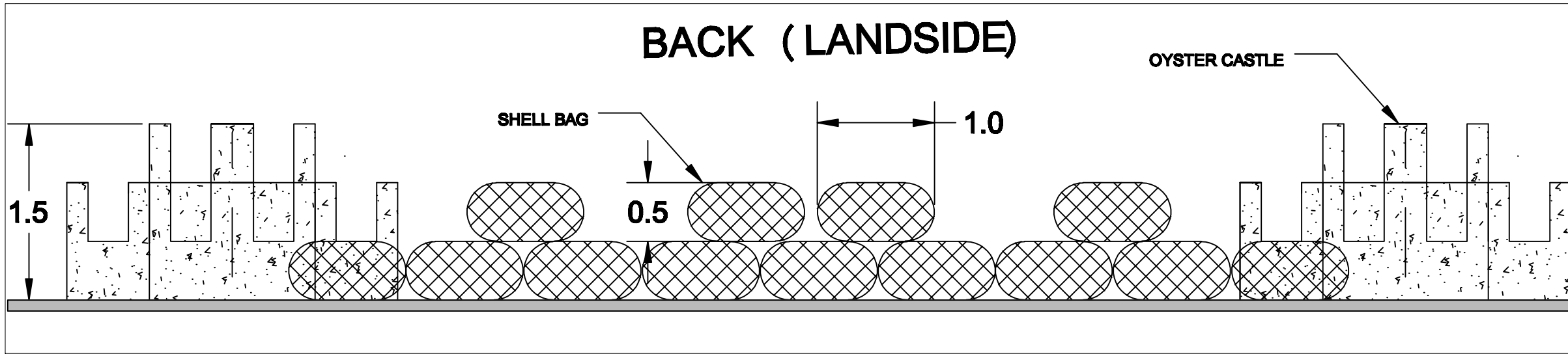
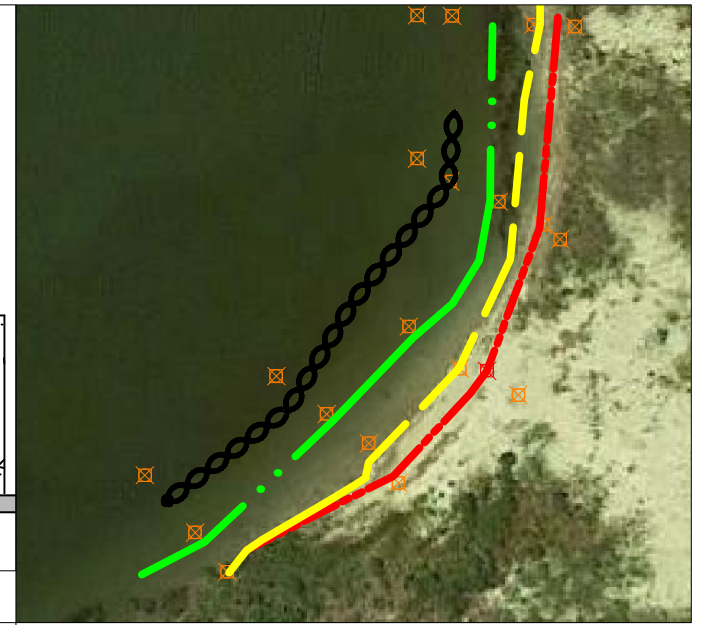
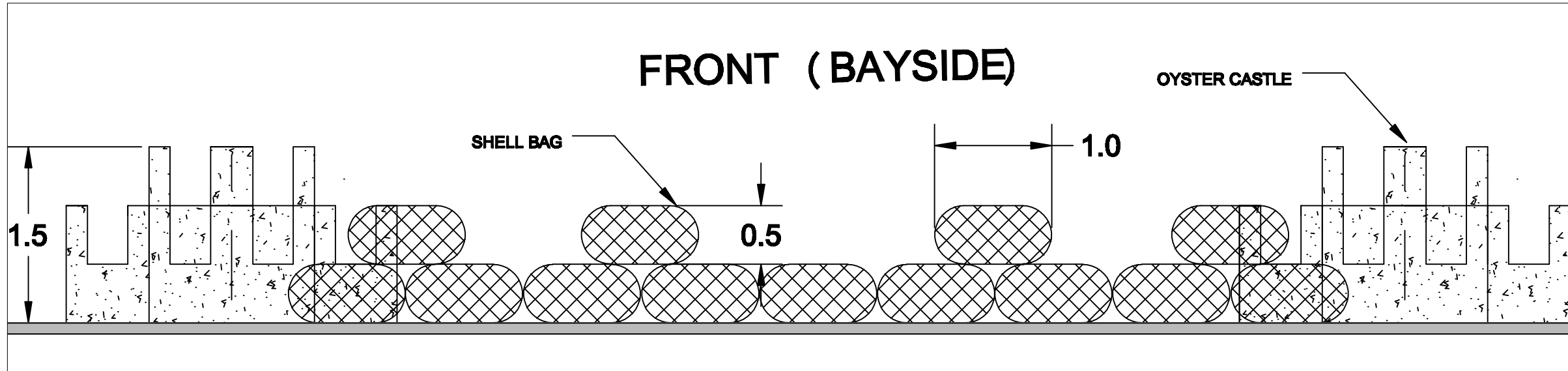

INLET ROAD EAST
39401 INLET ROAD
REHOBOTH BEACH, DELAWARE 19971

**DESIGN
BRAIDED REEF
DETAILS**

DELAWARE CENTER FOR THE INLAND BAYS
39375 Inlet Road,
Rehoboth Beach, DE 19971
Phone: (302) -228-8108
www.inlandbays.org

SOVEREIGN CONSULTING INC.
50 West Welsh Pool Rd., Suite 6
Exton, Pennsylvania 19341
Phone: (610) 524-8124 Fax: (610) 524-8129
www.sovcon.com

Created By: DJS	Original: 9/30/16	Figure:
Revision Date	By	Sheets Affected
11.22.16	DJS	ALL

3.2